

Pavilion H,
by Kettal Studio

kettal

Description

Pavilion H

Designer
Kettal Studio

Collection
Pavilions

This new series of pavilions brings the system even closer to architecture, as we have developed more tools for its integration in the architectural environment. The system is now able to adapt more efficiently to different uses and environments: landscapes, architecture, urban environment, maritime, mountain, and so on.

	Height	Width	Length
Simple			
4x4	260 / 102,3"	404,5 / 159,2"	404,5 / 159,2"
6x4	260 / 102,3"	600 / 236,2"	404,5 / 159,2"
6x6	260 / 102,3"	600 / 236,2"	600 / 236,2"
Double			
8x4	260 / 102,3"	799 / 314,5"	404,5 / 159,2"
8x6	260 / 102,3"	600 / 236,2"	799 / 314,5"
12x4	260 / 102,3"	1190 / 468,5"	404,5 / 159,2"
12x6	260 / 102,3"	1190 / 468,5"	600 / 236,2"

Bespoke sizes on demand



Standard sizes

Pavilion H

Designer
Kettal Studio

Collection
Pavilions

4x4 Simple Pavilion

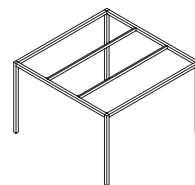
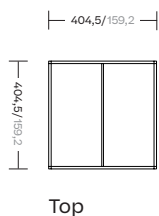
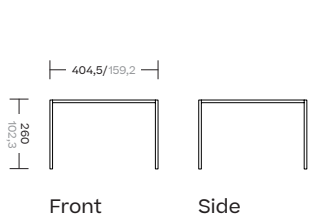

6x4 Simple Pavilion

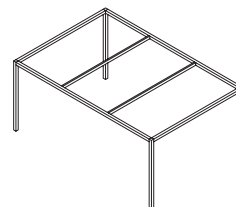
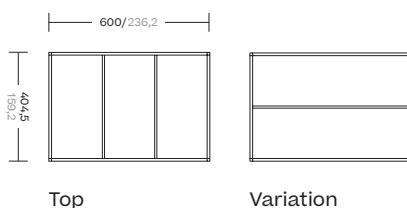
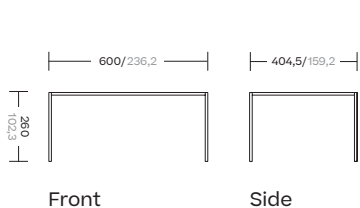

6x6 Simple Pavilion

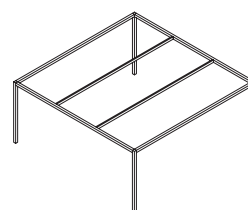
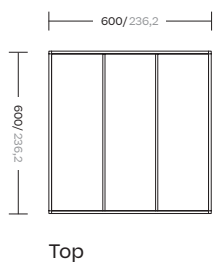
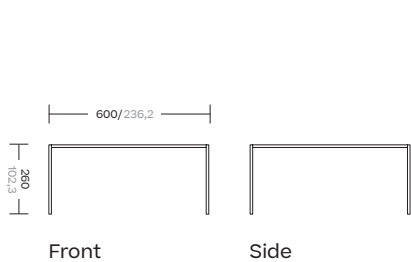

8x4 Double Pavilion

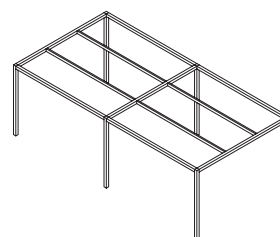
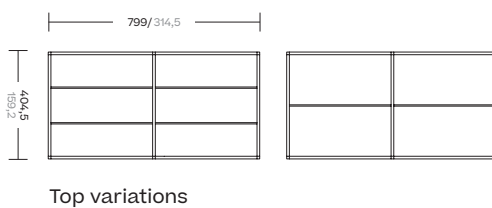
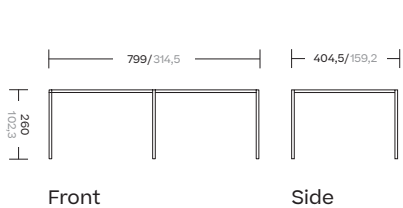

Standards sizes

Pavilion H

Designer
Kettal Studio

Collection
Pavilions

8x6 Double Pavilion

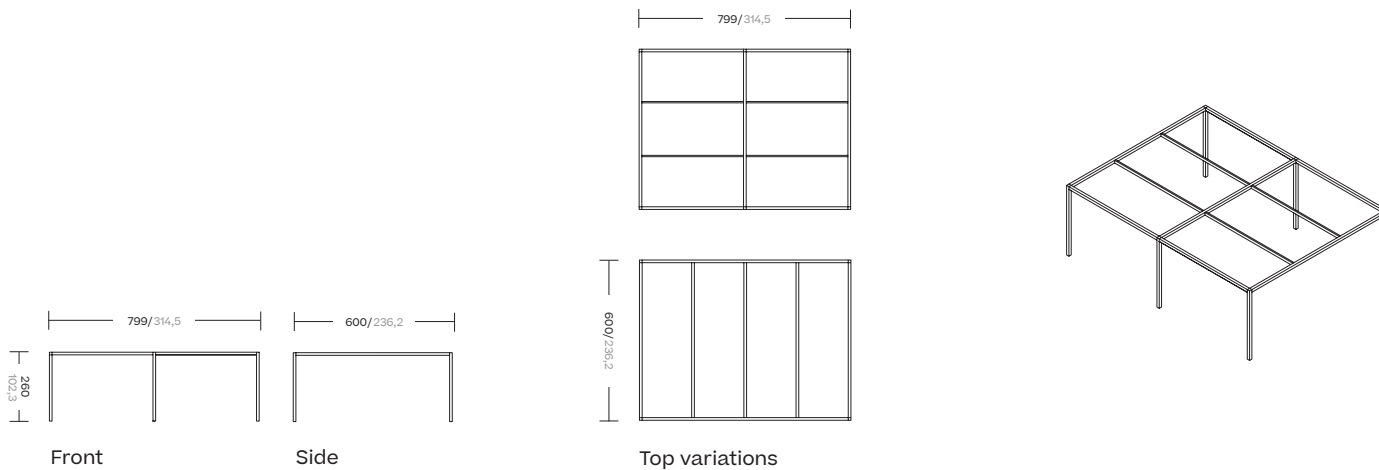

12x4 Double Pavilion

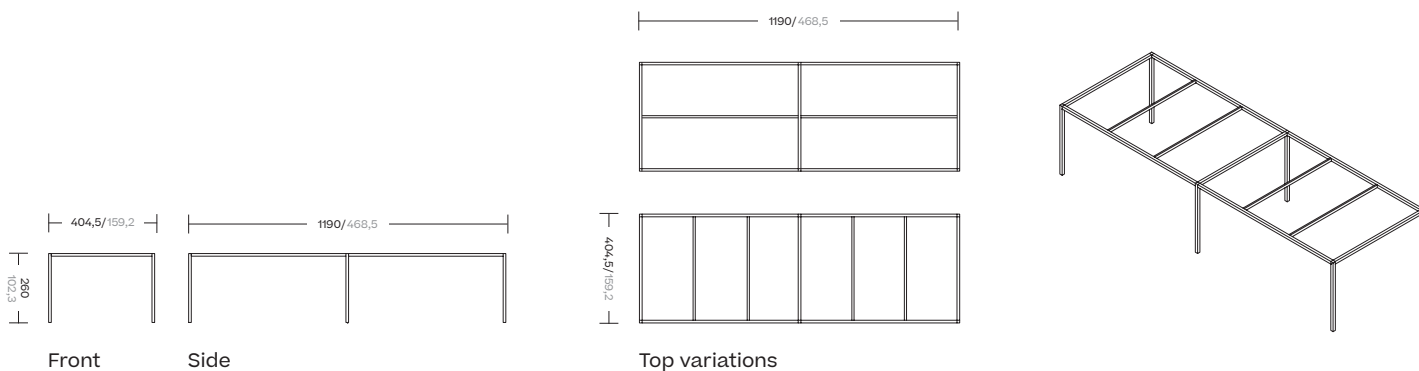

12x6 Double Pavilion

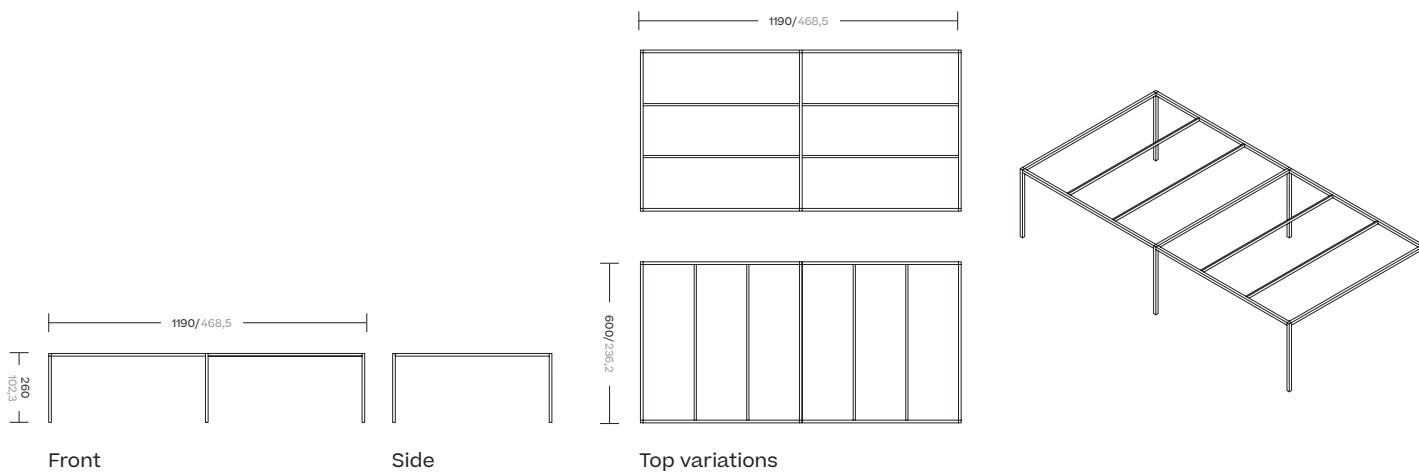

Isometric view

Pavilion H

Designer
Kettal Studio

Collection
Pavilions

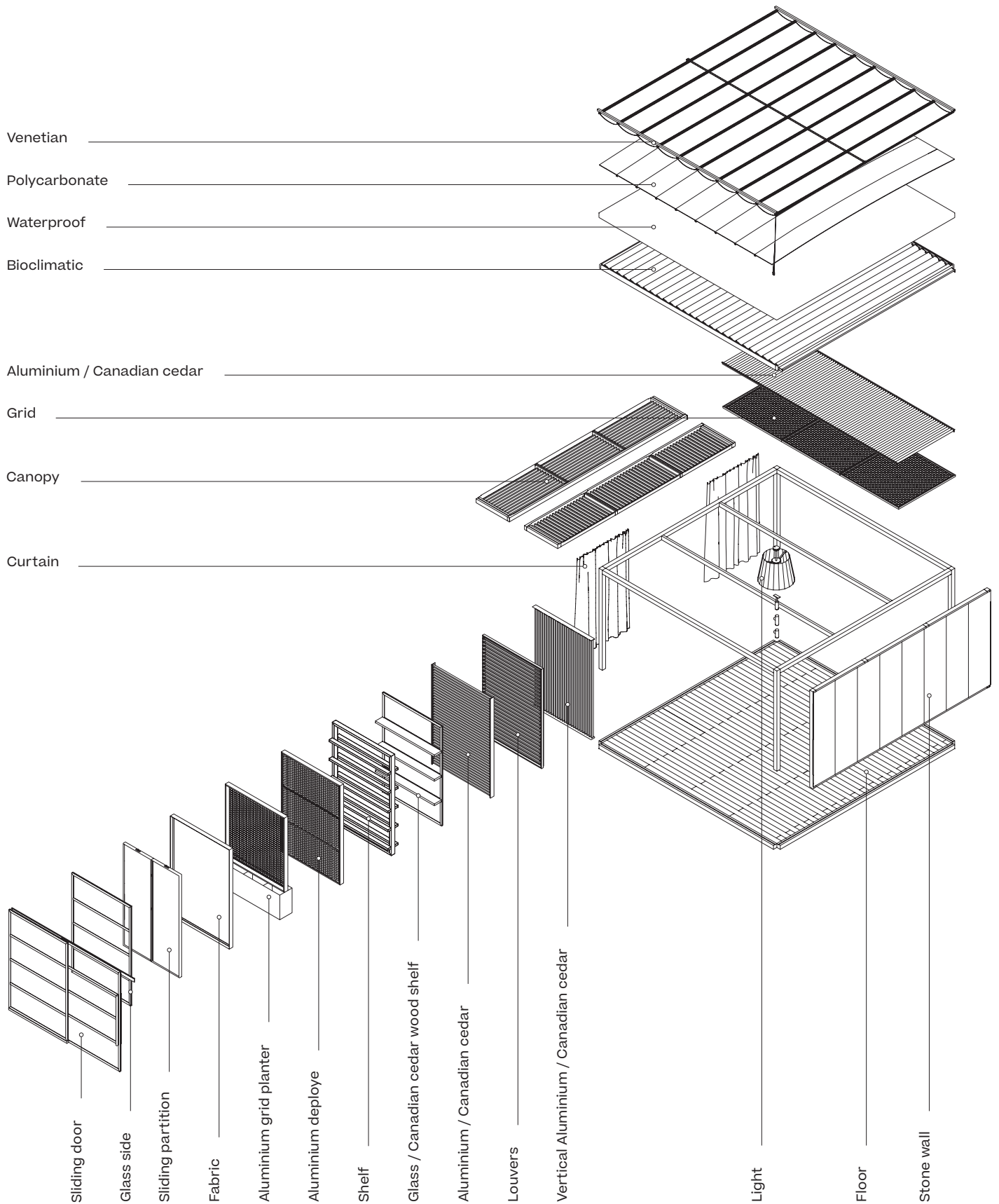

Side parts

Pavilion H

Designer
Kettal Studio

Collection
Pavilions

Fabric

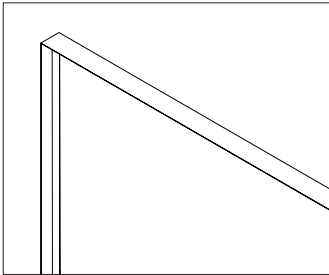

Fabric side panel

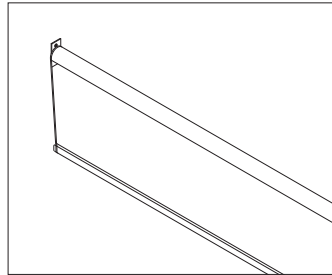

Rolling blind

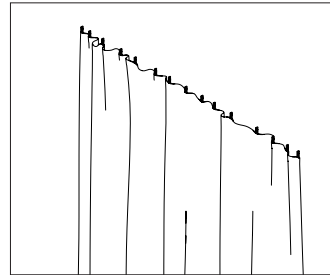

Curtain/sheers

Glass

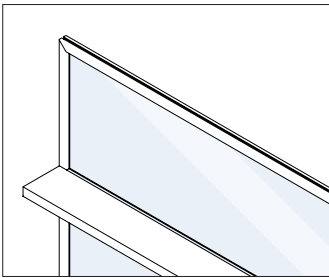

Shelf glass panel

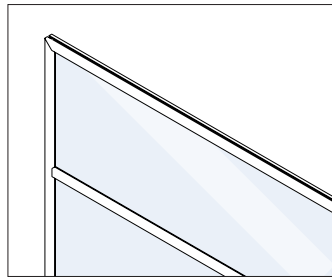

Glass side panel

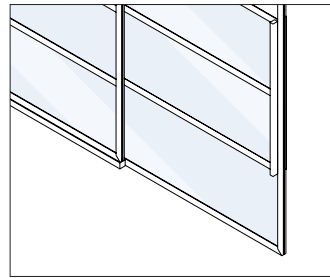

Sliding door

Stone

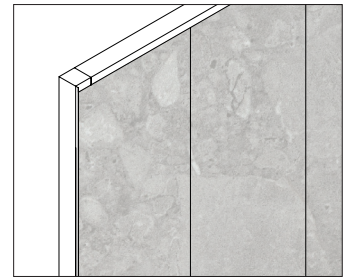

Stone wall

Wood

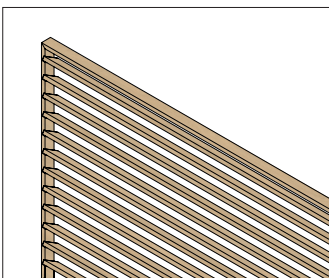

Wood louvers side panel

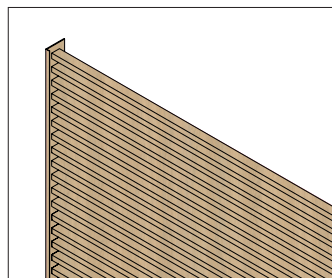

Wood side panel

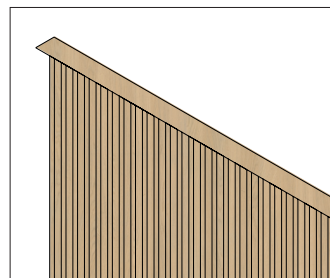

Wood vertical side panel

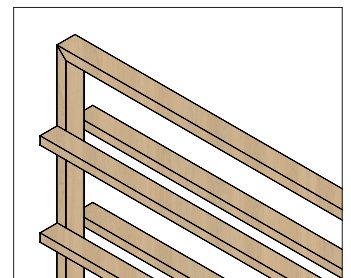

Wood shelf side panel

Side parts

Pavilion H

Designer
Kettal Studio

Collection
Pavilions

Aluminium

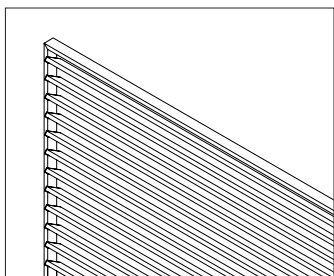

Aluminium louvers side panel

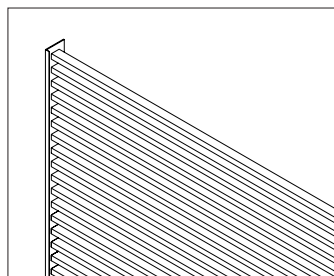

Aluminium side panel

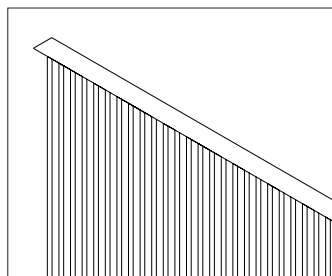

Aluminium vertical side panel

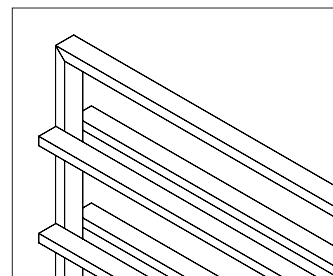

Aluminium shelf side panel

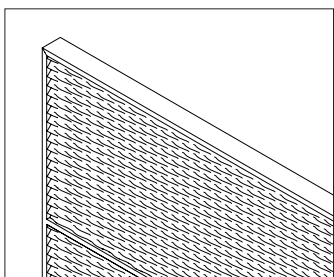

Deploye side panel

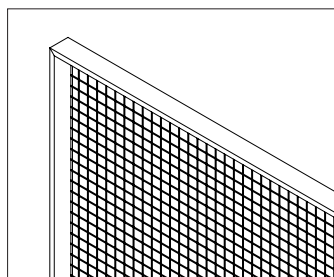

Grid planter side panel

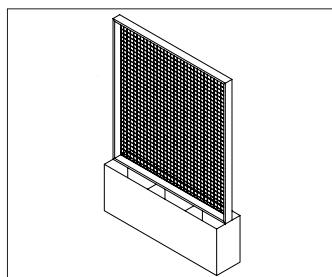

Sliding walls

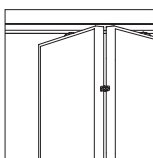

Fabric

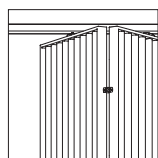

Aluminium

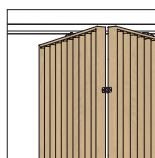

Wood



Ceiling

Pavilion H

Designer
Kettal Studio

Collection
Pavilions

Waterproof

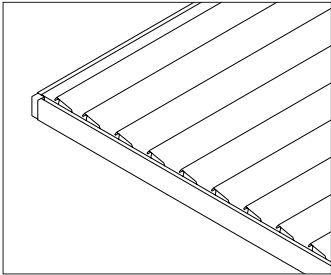

Bioclimatic electric ceiling

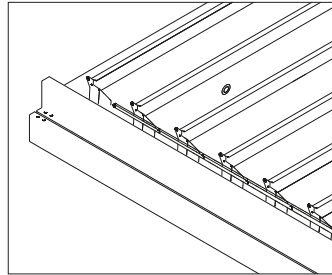

Bioclimatic electric ceiling
with minidots

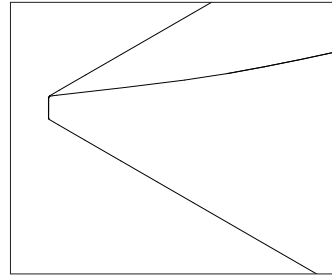

Waterproof sunroof

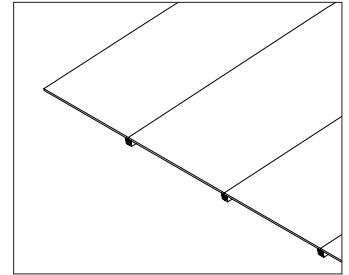

Polycarbonate ceiling

Aluminium/Wood ceilings

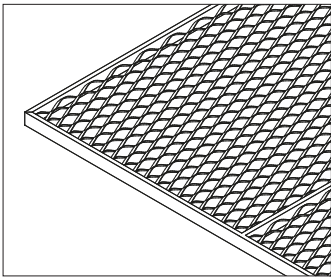

Deploye ceiling

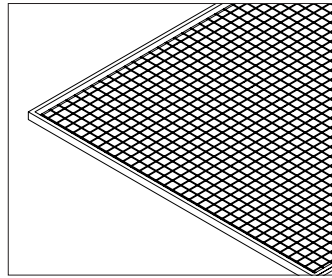

Grid ceiling

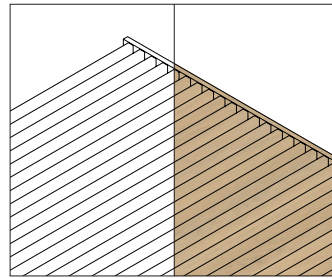

Aluminium Wood

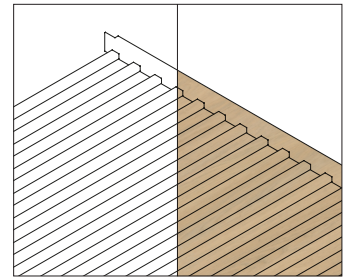

Light
Aluminium Light
Wood

Fabric ceilings

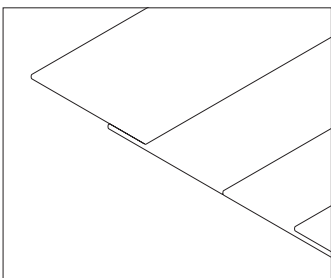

Sliding roof

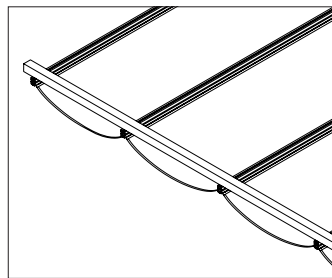

Shelter venetian roof
(waterproof and nonwaterproof)

Canopy

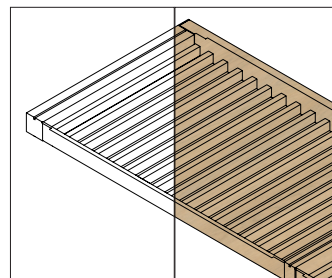

Aluminium Wood

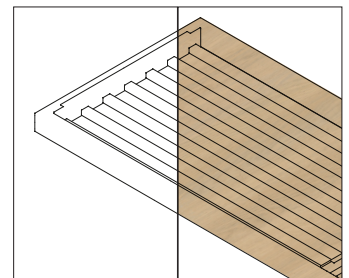

Light
Aluminium Light
Wood

Floors & accessories

Pavilion H

Designer
Kettal Studio

Collection
Pavilions

Led lights

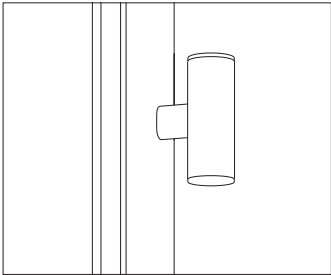

Down spotlight

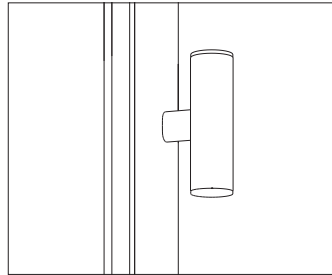

Up and down spotlight

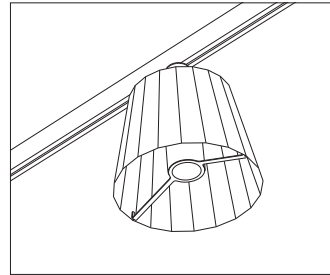

Lamp

Accessories

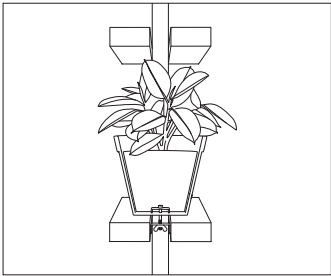

Flower pot

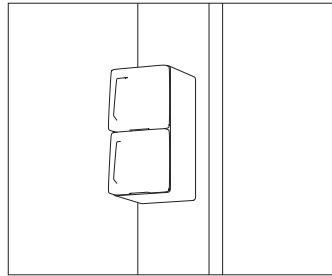

Power outlet

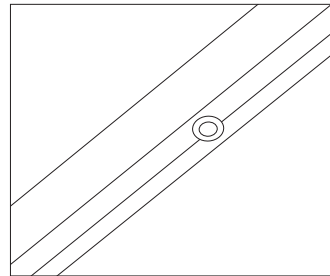

Switch

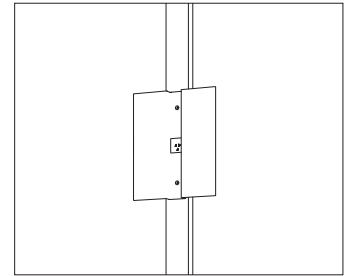

TV Mount

Floor

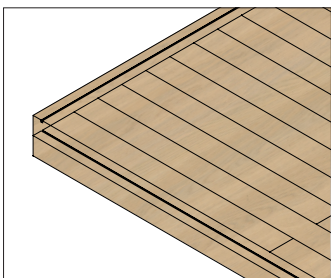

Floor

Structure

kettal

Standards sizes

Pavilion H

Designer
Kettal Studio

Collection
Pavilions

4x4 Simple Pavilion

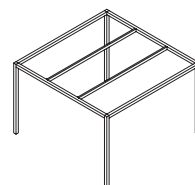
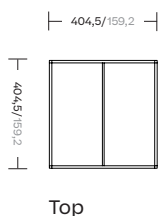
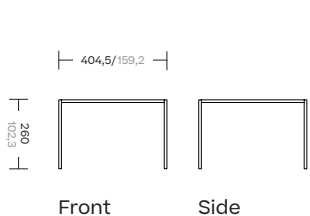

6x4 Simple Pavilion

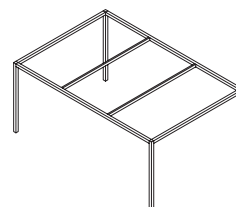
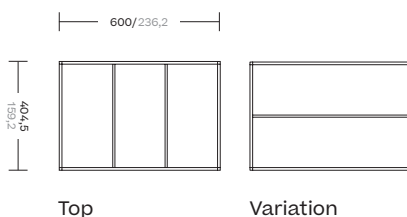
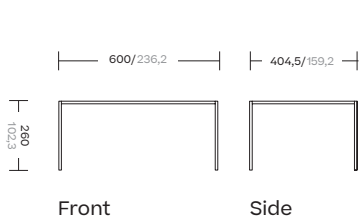

6x6 Simple Pavilion

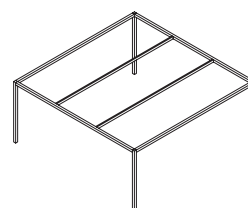
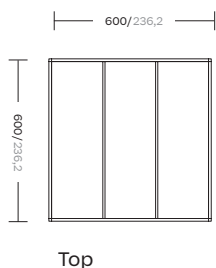
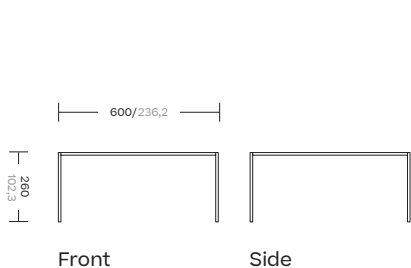

8x4 Double Pavilion

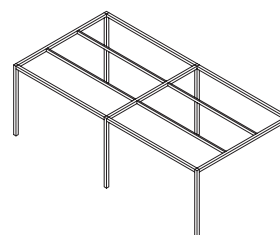
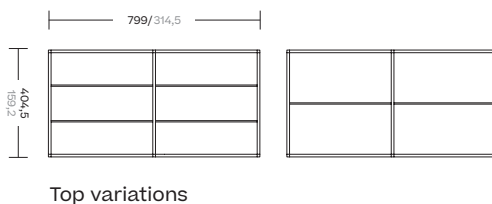
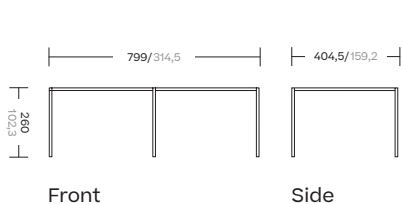

Standards sizes

Pavilion H

Designer
Kettal Studio

Collection
Pavilions

8x6 Double Pavilion



12x4 Double Pavilion

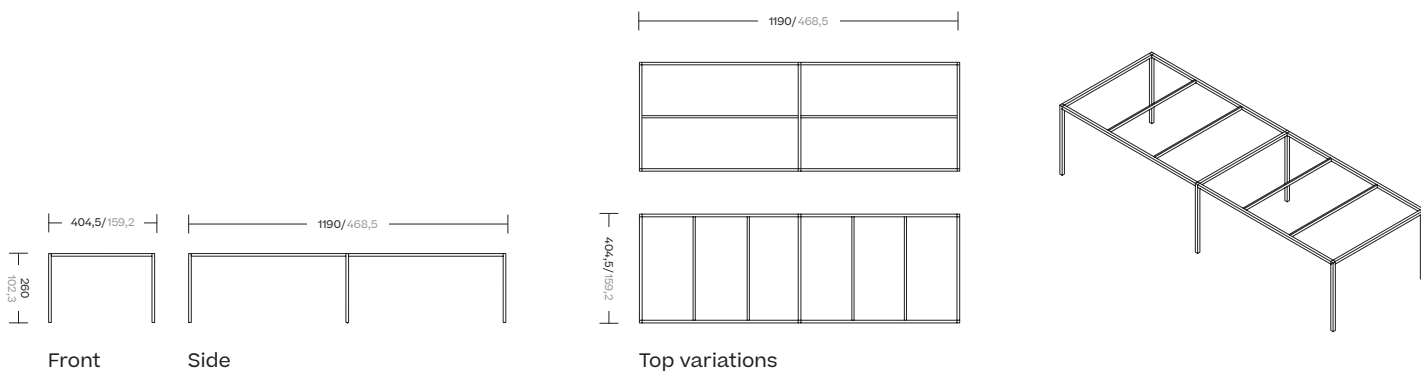

12x6 Double Pavilion

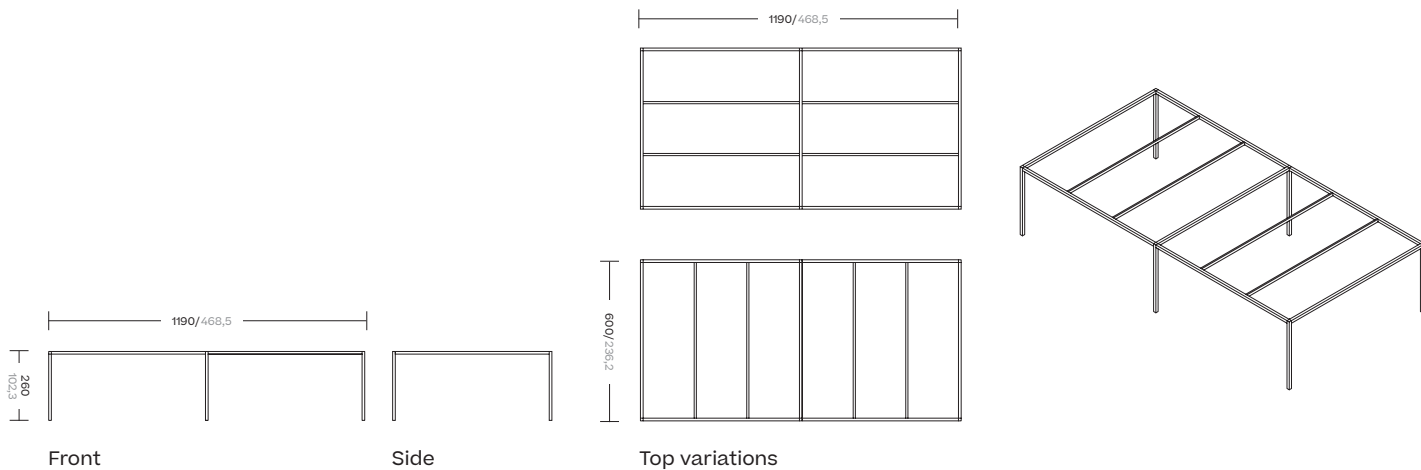

Columns

The columns described below are components used in both standard and bioclimatic pavilions. This means that the sides are compatible in both cases. The difference, however, is that the bioclimatic column is machined at the bottom for the drain.

Profile with two slits that allow the side panels and anchoring base to be attached.

The material is aluminium alloy 6005 T6.

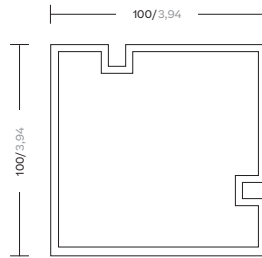

Corner Column

17 kg

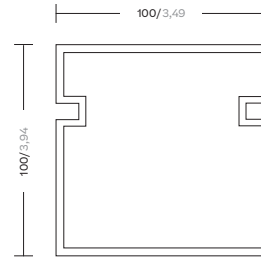

Central Double Column

19,9 kg

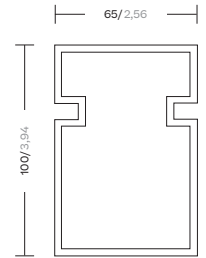

Auxiliary Column

Not considered structural

8,4 kg

Crossbeams

The crossbeams described below are components used exclusively in standard pavilions. Profile with several slits that are used to attach the side panels and the roofs. The material is aluminium alloy 6005 T6.

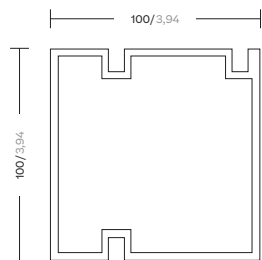

Simple Beam

4m - 30,1 kg
6m - 45,5 kg

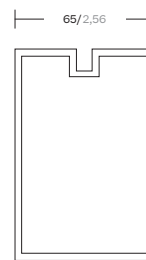

Secondary Beam (<4m)

20,53 kg

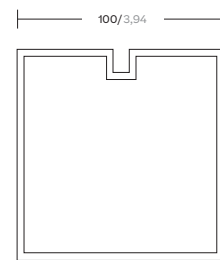

Double Beam

4m - 31,2 kg
6m - 47,1 kg

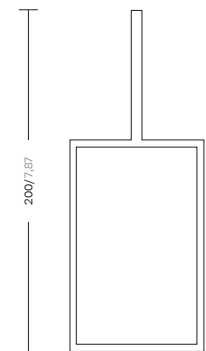

Secondary Beam (>4m)

47,69 kg

Bioclimatic

The crossbeams described below are components used exclusively in bioclimatic pavilions.

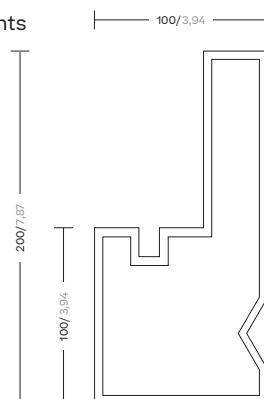

BIO Simple Beam

4m - 47,1 kg
6m - 71,2 kg

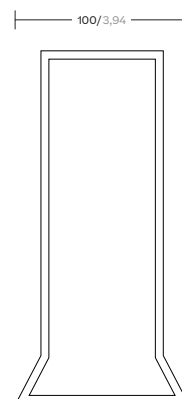

BIO Secondary Beam (>4m)

52,76 kg

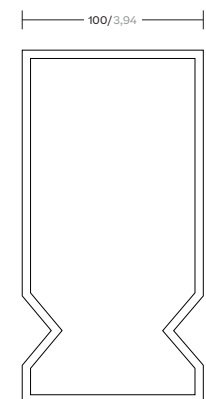

BIO Double Beam

4m - 42,6 kg
6m - 64,4 kg

Footers

The footers are essential components that ensure the stability and durability of the structures. These elements are designed to provide a solid foundation, ensuring that the pavilions can withstand various weather and terrain conditions. The footers are made from high-quality materials and are designed to integrate seamlessly with the overall design of the pavilions.

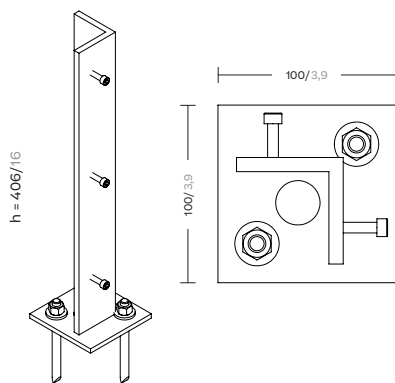

Corner Column Footer

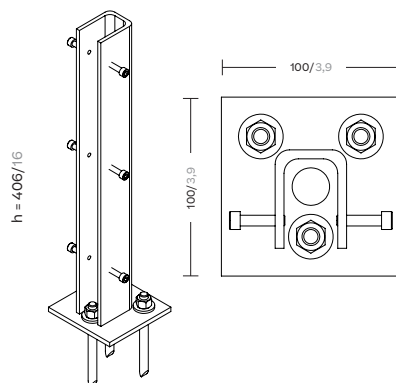

Double Column Footer

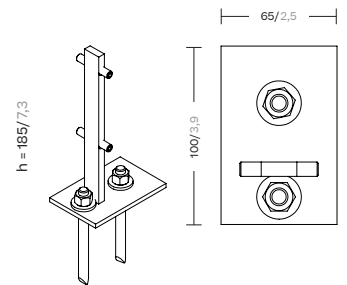

Auxiliary Column Footer