

C.E.O. Cube Meeting Table — L. and M. Vignelli — 2008



La nuova linea esprime il desiderio di superfici leggere consono alle espressioni architettoniche contemporanee. Il contrasto tra il volume della cassettiera - libreria e le superfici sottili del piano di scrittura ed il pannello di supporto, conferisce alla scrivania snellezza ed autorità, elementi caratteristici del management contemporaneo. Il tavolo riunioni riprende lo stesso linguaggio in dimensioni variabili, rettangolare, quadrato o tondo.

CARATTERISTICHE TECNICHE

Modelli e dimensioni.

- Square Meeting Table
- Round Meeting Table ø150
- Round Meeting Table ø180
- Low Round Meeting Table ø150
- Low Round Meeting Table ø180
- Rectangular/Oval Meeting Table
 - 296×150
 - 369×150
 - 442×150
 - 515×150
 - 588×150
 - 661×150
 - 734×150

Struttura portante. In ferro verniciato nero.

Piano. In MDF con doppia pannellatura a bordo smussato: il pannello inferiore è verniciato nero testurizzato mentre quello superiore è rivestito in pelle.

Rivestimento piano. In Pelle Frau® Color System (SC).

Gambe. In tubolare metallico di forma cilindrica, leggermente imbottite e rivestite in pelle. Puntali registrabili in materiale plastico.

RECTANGULAR/OVAL MEETING TABLE

Versioni.

- Senza pannelli centrali
- Con pannelli centrali
- Hardware con pannelli centrali e passacavi
- Hardware con sportelli centrali e passacavi

Con pannelli centrali. È dotata di un tunnel passacavi in lamiera di metallo traforata e verniciata di colore nero. Al di sopra del tunnel passacavi si estende una fila di pannelli in MDF rivestiti in pelle.

Hardware con pannelli centrali e borchie passacavi. Presenta, in aggiunta alla versione precedente, una serie di borchie in metallo inserite al centro di ciascun pannello centrale che consentono l'uscita dei cavi sul piano e disponibili nella versione:

- Cromata
- Verniciata nera.

The new series epitomises the desire for light surfaces that are in keeping with contemporary architectural expression. The contrast between the volume of the drawer chest-bookcase and the slender surfaces of the desktop and the supporting panel gives the desk a streamlined and authoritative feel, distinctive characteristics of contemporary management. The meeting table adopts the same language in variable dimensions, rectangular, square or round.

TECHNICAL FEATURES

Items and sizes.

- Square Meeting Table
- Round Meeting Table ø150
- Round Meeting Table ø180
- Low Round Meeting Table ø150
- Low Round Meeting Table ø180
- Rectangular/Oval Meeting Table
 - 296×150
 - 369×150
 - 442×150
 - 515×150
 - 588×150
 - 661×150
 - 734×150

Supporting structure. In black painted iron.

Top. Rounded-edge double panelling made of MDF: the bottom panel has a black textured finish while the top is covered in leather.

Top covering. In Pelle Frau® Color System (SC) leather.

Legs. Tubular metal legs with a cylindrical shape, lightly padded and leather-covered. Adjustable plastic caps.

RECTANGULAR/OVAL MEETING TABLES

Versions.

- Without central panels
- With central panels
- Hardware with central panels and cable management
- Hardware with central doors and cable management

With central panels. It features a cable management tunnel in black perforated sheet steel. The row of MDF panels above the cable tunnel are leather-covered.

Hardware with central panels and cable grommets. It features the same tunnel as the version above plus a series of metal grommets, which allows the cables to come out, located in the middle of each central panel and available in a:

- Chrome finishing
- Black stained finishing

Hardware con sportelli centrali e passacavi. È attrezzata, nella parte centrale del piano, al di sopra del tunnel passacavi, con una serie di sportelli rivestiti in pelle. Ogni sportello dà accesso a un vano interno dotato di una borchia passacavi in metallo disponibile nella versione:

- Cromata
- Verniciata nera

Su richiesta, è possibile personalizzare i vani interni con un dispositivo di elettrificazione fornito dal cliente e da acquistare separatamente.

Nota bene. Su richiesta, e con quotazione da valutare di volta in volta, i pannelli centrali possono essere impiallacciati con essenze legnose disponibili nel campionario legni Poltrona Frau.

Predisposizione passaggio cavi. Fornita e personalizzata in base ai dispositivi di elettrificazione scelti e specificati dal cliente in fase di acquisto. Tali dispositivi devono essere acquistati ed installati dal cliente successivamente alla consegna. Per assicurare una corretta predisposizione in fase produttiva si raccomanda l'invio di un campione.

Optional (solo per Meeting Table rettangolari).

- Con "President area"
 - Senza "President area"
-

"President area". È prevista, a scelta, in uno dei due lati corti dei Meeting Table rettangolari. È rivestita in pelle in abbinamento al piano o di colore differente.

Nella stessa collezione.

- C.E.O. Cube Bookcase
- C.E.O. Cube Cabinet
- C.E.O. Cube Desk

Hardware with central doors and cable managements. It features, in the central part of the tabletop, above the cable passageway, a series of doors covered in leather. Each door gives access to an internal compartment equipped with a metal cable grommet available in a:

- Chrome finishing
- Black stained finishing

Upon request, it is possible to personalise the internal compartments with an electrical device supplied by the customer and purchased separately.

Please note. Upon request, and with prices to be evaluated as required, the central panels can be veneered in the different woods available from the Poltrona Frau wood samples.

Predisposition for the cable management system. It is supplied and personalised based on the electrical devices chosen and specified by the customer at the time the order is placed. These devices must be purchased and installed by the client following delivery. To ensure proper placement during the production process, customers are strongly encouraged to submit a sample.

Accessories (only for rectangular Meeting Tables).

- With President area
 - Without President area
-

President area. If provided, it can be placed on one of the two shorter sides of the rectangular Meeting Tables. It is covered in leather, matching the top or in a different colour.

In the same collection.

- C.E.O. Cube Bookcase
 - C.E.O. Cube Cabinet
 - C.E.O. Cube Desk
-

5175626

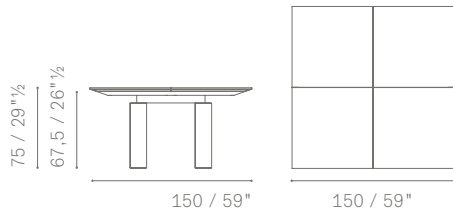

5175631

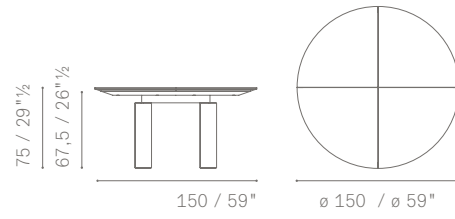

5175632

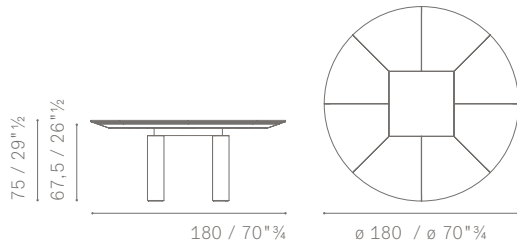

5175631

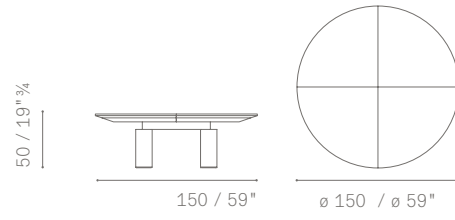

5175632

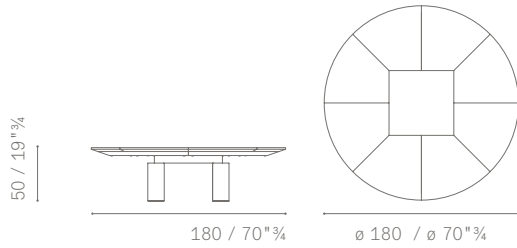

RECTANGULAR / OVAL MEETING TABLE

I PIANI SONO DISPONIBILI IN 4 VERSIONI: STANDARD, CON PANNELLI CENTRALI E 2 VERSIONI HARDWARE, DIVERSAMENTE CONFIGURABILI PER IL PASSAGGIO CAVI.

TABLES AVAILABLE IN 4 VERSIONS: STANDARD, WITH CENTRAL PANELS AND 2 HARDWARE VERSIONS, THAT CAN BE CONFIGURABLE WITH CABLE MANAGERMENTS.

VERSIONE STANDARD (SENZA PANNELLI CENTRALI) / STANDARD VERSION (WITHOUT CENTRAL PANELS)

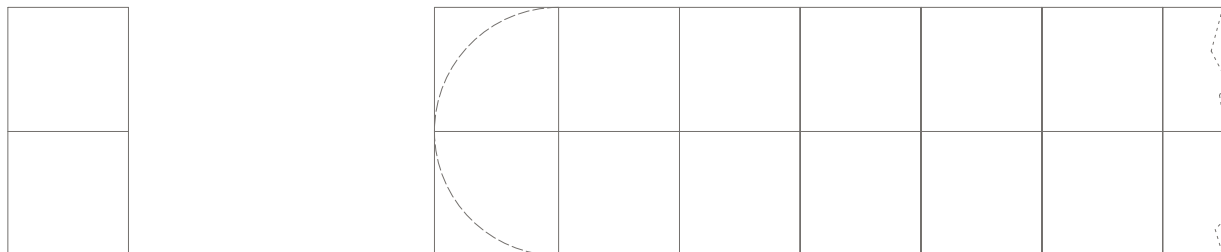

CON PANNELLI CENTRALI (*) / WITH CENTRAL PANELS (*)

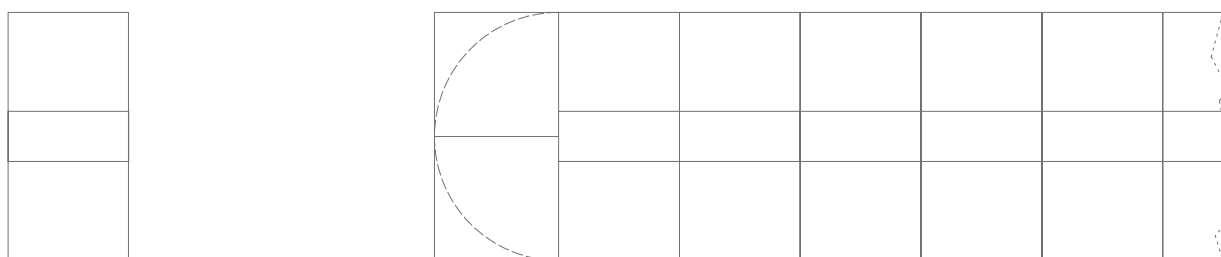

HARDWARE CON PANNELLI CENTRALI E BORCHIE PASSACAVI / HARDWARE WITH CENTRAL PANELS AND CABLE GROMMETS

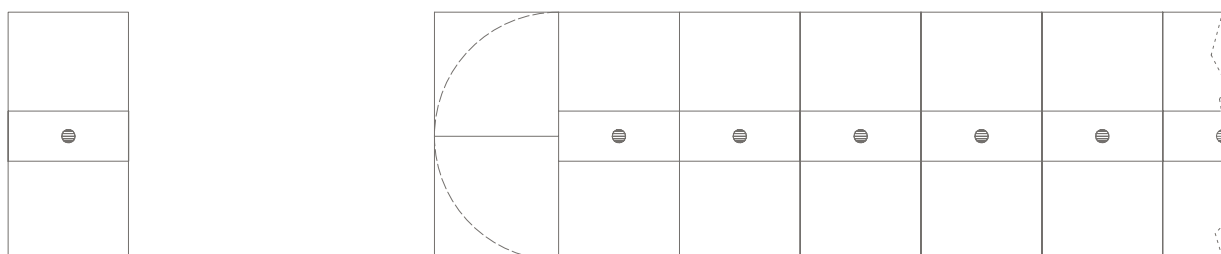

HARDWARE CON SPORTELLI CENTRALI E BORCHIE PASSACAVI / HARDWARE WITH CENTRAL DOORS AND CABLE GROMMETS

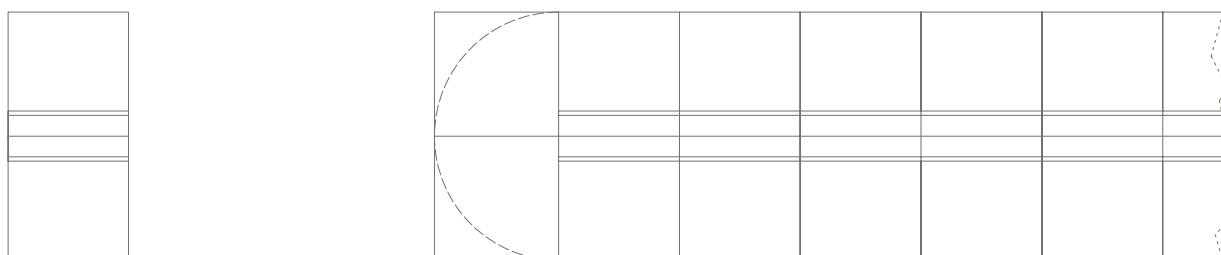

(*) La struttura, le gambe e il telaio del tavolo sono predisposti per il passaggio cavi. Su richiesta, i pannelli centrali del piano possono essere equipaggiati con accessori elettrici forniti dal cliente e approntati da Poltrona Frau.

N.B. Le quotazioni e i tempi di consegna variano a seconda della personalizzazione richiesta e saranno comunicati di volta in volta. Poltrona Frau può approntare i tavoli per accogliere accessori elettrici ma non può fornire il prodotto cablato.

(*) Structure, legs and frame of the table are suited for the cable management. On request, the central panels can be equipped with power sockets supplied by the client and set up by Poltrona Frau.

Please Note. Prices and delivery terms may vary depending on the customization requested that will be communicated individually. Poltrona Frau can set up the tables for the power sockets but can not provide the wired product.

OPTIONAL: PRESIDENT AREA

È PREVISTA, A SCELTA, IN UNO DEI DUE LATI CORTI DEI MEETING TABLE RETTANGOLARI. IL RIVESTIMENTO IN PELLE FRAU® SC DELLA “PRESIDENT AREA” PUÒ ESSERE PREVISTO DI COLORE DIFFERENTE DAL RIVESTIMENTO DEL PIANO.

AVAILABLE, BY CHOICE, FOR ONE OF THE TWO SHORT SIDE OF THE RECTANGULAR MEETING TABLES. THE UPHOLSTERY IN PELLE FRAU® SC OF THE “PRESIDENT AREA” CAN BE PROVIDED IN A DIFFERENT COLOR INSTEAD OF THE TOP.

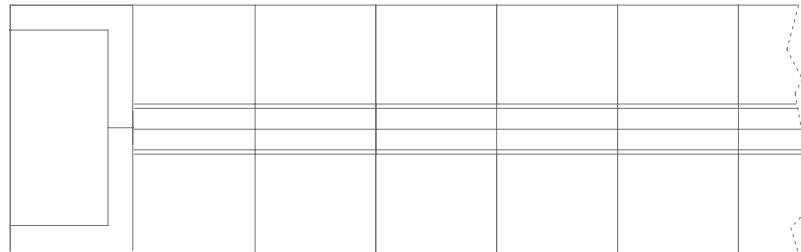
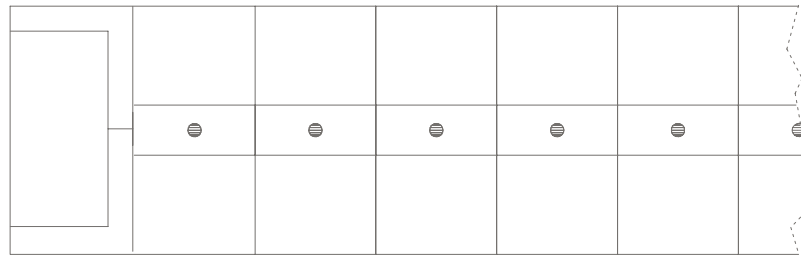
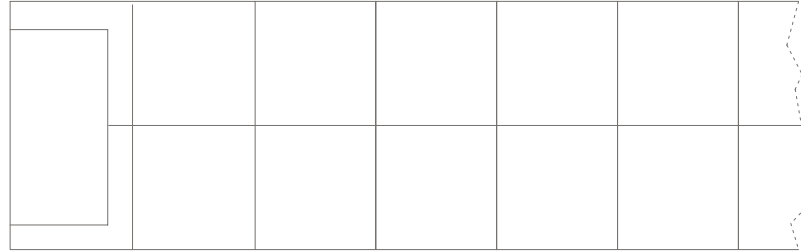

C.E.O. CUBE MEETING TABLES

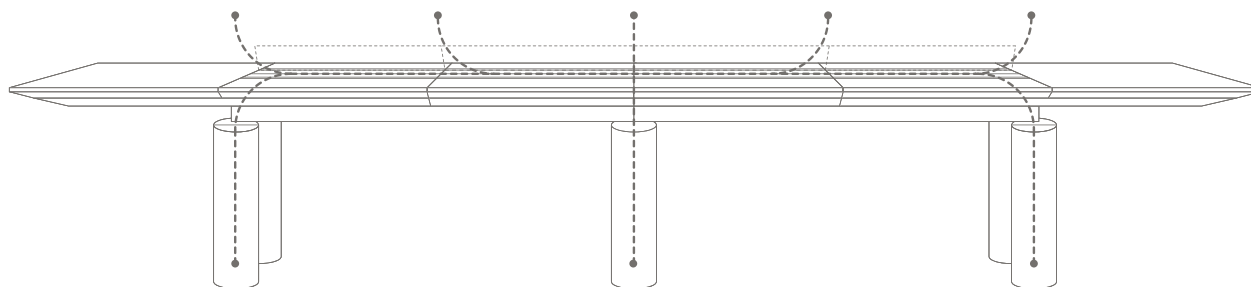
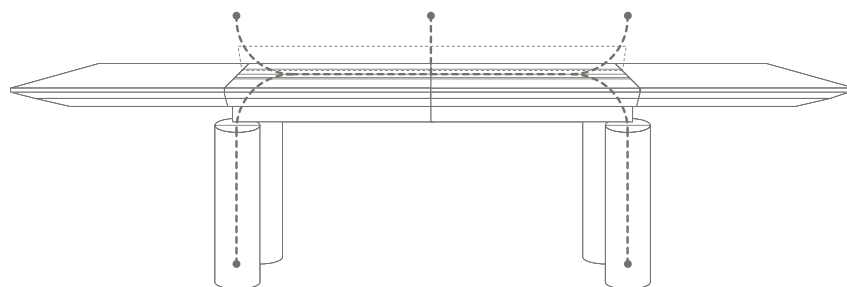

5175621 Rectangular
5175636 Oval

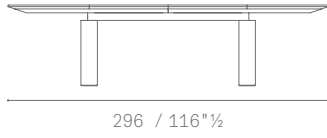
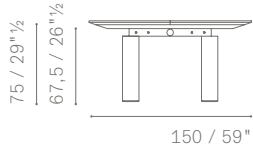
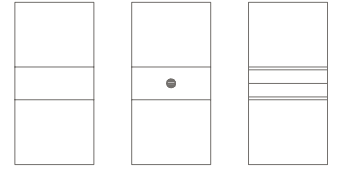
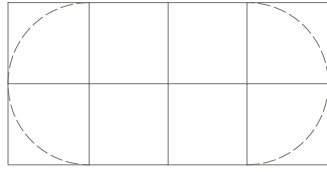

5175622 Rectangular
5175637 Oval

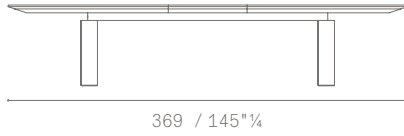
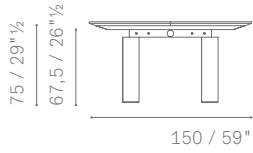
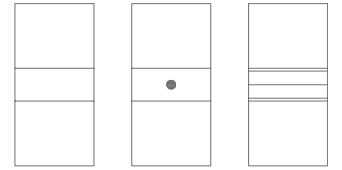
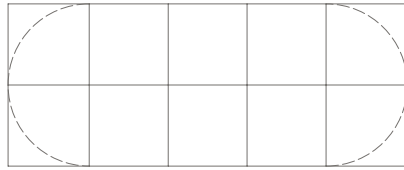

5175621 Rectangular
5175636 Oval

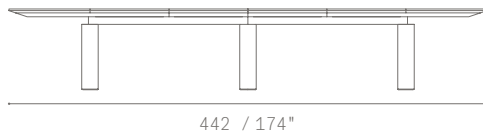
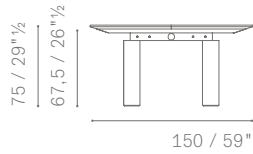
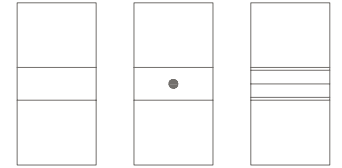
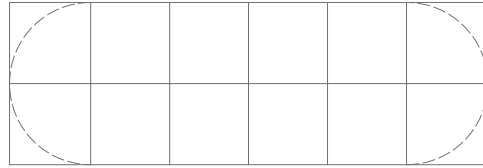

5175621 Rectangular
5175636 Oval

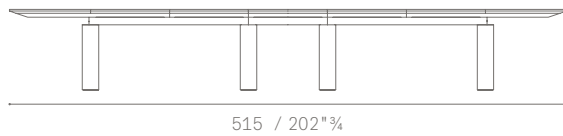
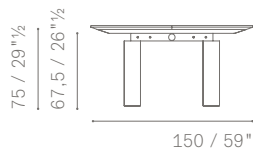
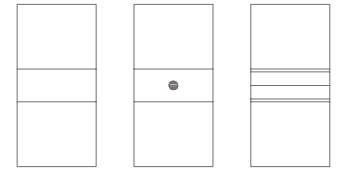
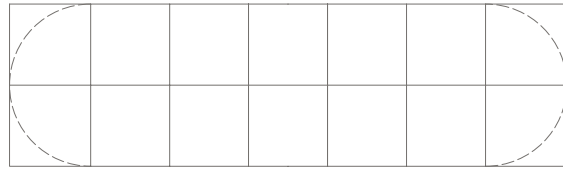

5175621 Rectangular
5175636 Oval

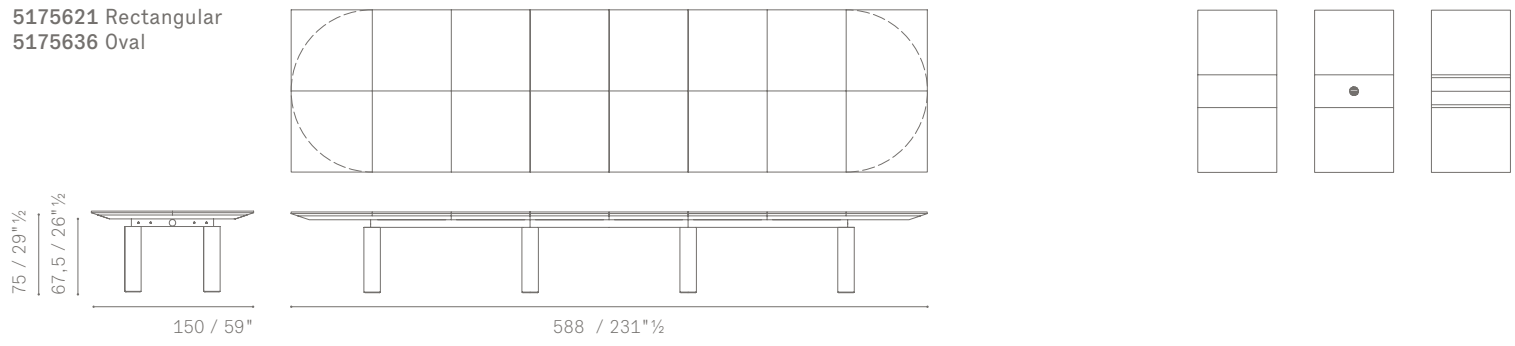

5175622 Rectangular
5175637 Oval

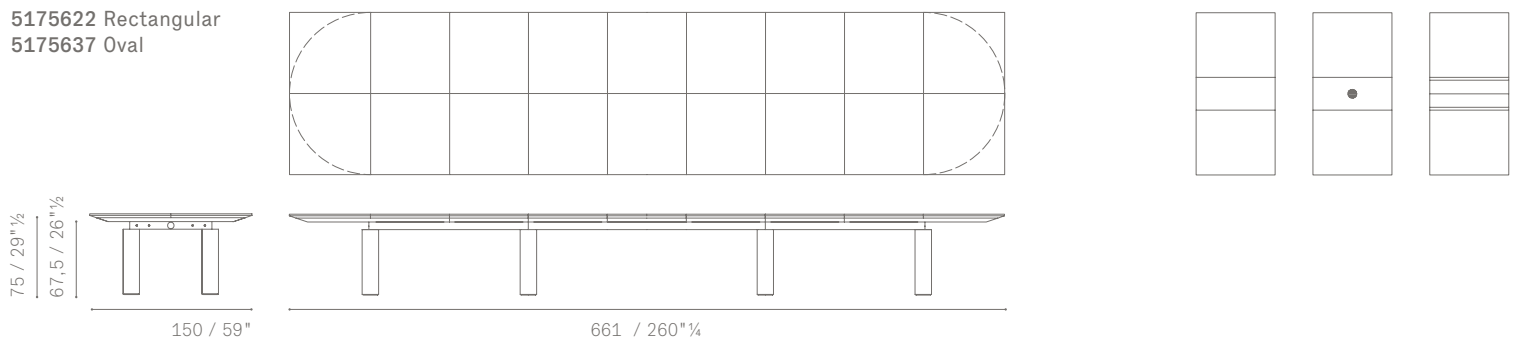

5175621 Rectangular
5175636 Oval

