

QUADRIFOGLIO

C. Ballabio

2018



QUADRIFOGLIO

C. Ballabio

2018

Tavolo da pranzo rettangolare con quattro gambe rientranti e cornice del piano in massello di frassino. Inserto piano in cristallo retroverniciato o in Rock. Piedini in ottone spazzolato.

Rectangular dining table with four recessed legs and top frame in solid ash. Top insert in back-coated glass or in Rock. Brushed brass feet.

Rechteckiger Esstisch mit vier Beinen und Rahmen aus massivem Eschenholz. Einsätze der Tischplatte aus lackiertem Glas oder in Rock in den Farben der Kollektion. Füsse aus gebürstetem Messing.

Table à manger rectangulaire avec quatre jambes relevantes et cadre du plateau en frêne massif. Insert du plateau en verre dépoli rétro-vernissé ou en Rock dans les coloris de la collection. Pieds en cuivre brossé.

Mesa de comedor rectangular con cuatro patas encajadas y marco de la tapa de fresno macizo. Inserto de la tapa en cristal retrobarnizado o en Rock. Pies de latón cepillado.

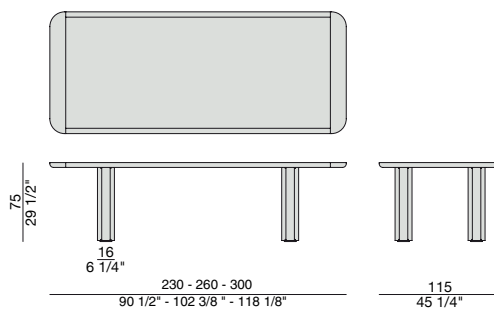

ESSENZE | *Essences*



Frassino Naturale
Natural Ash



Frassino
Ash
tinto/stained moka



Frassino
Ash
tinto noce canaletta
canaletta walnut stained



Frassino
Ash
tinto/stained wengé



Frassino
Ash
tinto/stained canapa

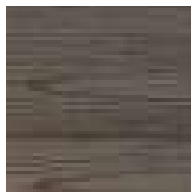

Frassino
Ash
tinto/stained caffè

LACCATO OPACO PORO APERTO | *Matt lacquered open pore*

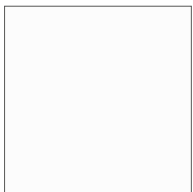

Bianco
White
(RAL 9016)

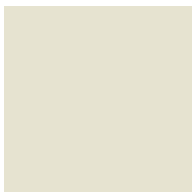

Avorio
Ivory
(RAL 1013)

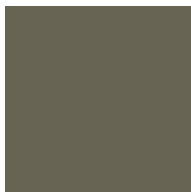

Argilla
Mud
(RAL 7006)



Piombo
Lead
(NCS S5005G20Y)



Cioccolato
Chocolate
(RAL 8019)

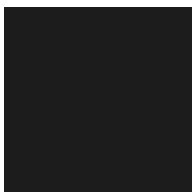

Nero
Black
(RAL 9005)

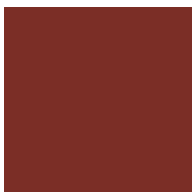

Granata
Garnet red
(NCS S4050Y90R)



Pistacchio
Pistachio green
(PANTONE 5825)



Avio
Aviation blue
(PANTONE 5415)

PIANO | *Top*

Rock



Calacatta
Calacatta

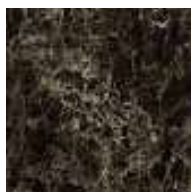

Emperador
Emperador

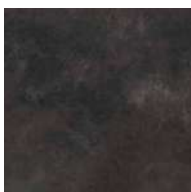

Oxide nero opaco
Matt oxide black

CRISTALLO | *Glass*

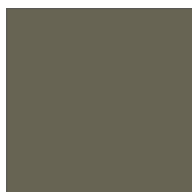

Laccato Argilla
Argilla lacquered

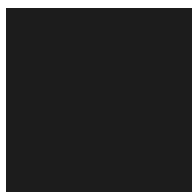

Laccato Nero
Black lacquered

METALLO | *Metal*



Ottone spazzolato
Brushed brass

QUADRIFOGLIO WOOD

C. Ballabio

2018

Tavolo da pranzo rettangolare con quattro gambe rientranti e cornice del piano in massello di frassino. Inserto piano dogato in frassino. Piedini in ottone spazzolato.

Rectangular dining table with four recessed legs and top frame in solid ash. Top insert in slatted ash wood. Brushed brass feet.

Rechteckiger Esstisch mit vier Beinen und Rahmen aus massivem Eschenholz. Einsätze der Tischplatte mit Escheleisten. Füße aus gebürstetem Messing.

Table à manger rectangulaire avec quatre jambes relevantes et cadre du plateau en frêne massif. Insert du plateau à lattes en frêne. Pieds en cuivre brossé.

Mesa de comedor rectangular con cuatro patas encajadas y marco de la tapa de fresno macizo. Inserto de la tapa en listones de fresno. Pies de latón cepillado.

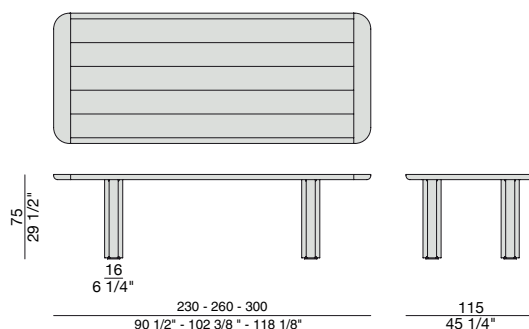

QUADRIFOGLIO WOOD

C. Ballabio

2018

ESSENZE | *Essences*



Frassino Naturale
Natural Ash



Frassino
Ash
tinto/stained moka



Frassino
Ash
*tinto noce canaletta
canaletta walnut stained*



Frassino
Ash
tinto/stained wengé



Frassino
Ash
tinto/stained canapa

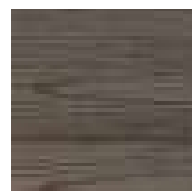

Frassino
Ash
tinto/stained caffè

LACCATO OPACO PORO APERTO | *Matt lacquered open pore*

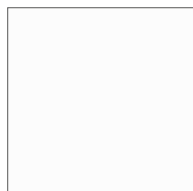

Bianco
White
(RAL 9016)

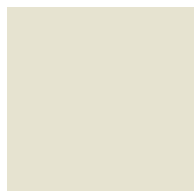

Avorio
Ivory
(RAL 1013)

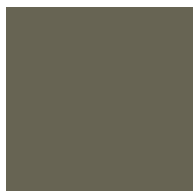

Argilla
Mud
(RAL 7006)



Piombo
Lead
(NCS S5005G20Y)



Cioccolato
Chocolate
(RAL 8019)



Nero
Black
(RAL 9005)



Granata
Garnet red
(NCS S4050Y90R)



Pistacchio
Pistachio green
(PANTONE 5825)



Avio
Aviation blue
(PANTONE 5415)

METALLO | *Metal*



Ottone spazzolato
Brushed brass

QUADRIFOGLIO CRYSTAL

C. Ballabio

2018

Tavolo da pranzo rettangolare o quadrato con quattro gambe in massello di frassino posizionate sui quattro angoli o rientranti in base alla misura del piano. Piano in cristallo trasparente (spessore mm. 15) con piastre elettrosaldate. Piastre e piedini in ottone

Rectangular or square dining table with four solid ash legs placed either on the corners or recessed depending on the size of the top. Clear glass top (thickness mm. 15) with UV-glued plates. Brushed brass plates and feet.

Rechteckiger oder quadratischer Esstisch mit vier Beinen aus massivem Eschenholz, die je nach Größe der Tischplatte entweder an den vier Ecken positioniert oder alternativ eingerückt sind. Tischplatte aus Klarglas (15mm) mit elektrisch geschweissten Metallplatten. Platten und Füße aus gebürstetem

Table à manger rectangulaire ou carrée avec quatre jambes en frêne massif placés sur les quatre angles ou relevants selon les dimensions du plateau. Plateau en verre transparent (épaisseur mm. 15) avec plaques soudé. Plaques et pieds en cuivre brossé.

Mesa de comedor rectangular o cuadrada con cuatro patas de fresno macizo en las esquinas o encajadas según el tamaño de la tapa. Tapa de cristal transparente (espesor mm. 15) con placas pegadas con UV. Placas y pies de latón cepillado.

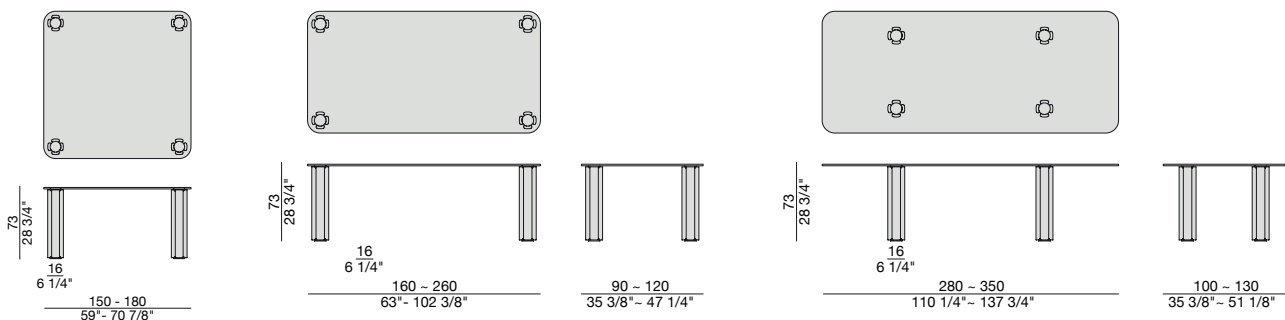

QUADRIFOGLIO CRYSTAL

C. Ballabio

2018

ESSENZE | *Essences*

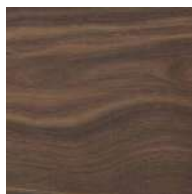

Noce Canaletta
Canaletta Walnut

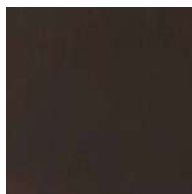

Noce Canaletta
Canaletta Walnut
tinto/stained moka

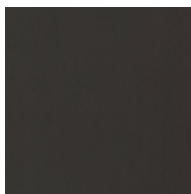

Noce Canaletta
Canaletta Walnut
tinto/stained wengé



Frassino Naturale
Natural Ash

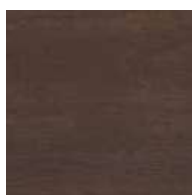

Frassino
Ash
tinto/stained moka



Frassino
Ash
*tinto noce canaletta
canaletta walnut stained*



Frassino
Ash
tinto/stained wengé



Frassino
Ash
tinto/stained canapa

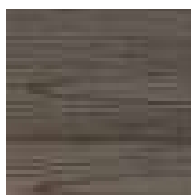

Frassino
Ash
tinto/stained caffè

QUADRIFOGLIO CRYSTAL

C. Ballabio

2018

LACCATO OPACO PORO APERTO | *Matt lacquered open pore*

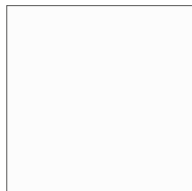

Bianco
White
(RAL 9016)

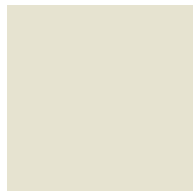

Avorio
Ivory
(RAL 1013)



Argilla
Mud
(RAL 7006)



Piombo
Lead
(NCS S5005G20Y)



Cioccolato
Chocolate
(RAL 8019)

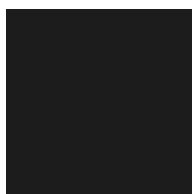

Nero
Black
(RAL 9005)



Granata
Garnet red
(NCS S4050Y90R)



Pistacchio
Pistachio green
(PANTONE 5825)

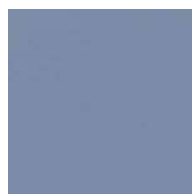

Avio
Aviation blue
(PANTONE 5415)

CRISTALLO | *Glass*

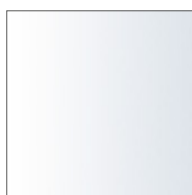

Trasparente
Transparent

METALLO | *Metal*



Ottone spazzolato
Brushed brass

QUADRIFOGLIO TONDO 1

C. Ballabio

2018

Tavolo da pranzo tondo con gamba centrale in massello di frassino montata su un anello di metallo in finitura Bronzoro. Piano in cristallo trasparente (spessore mm. 15) con piastra elettrosaldata in ottone spazzolato.

Round dining table with one central solid ash leg mounted on a metal ring in Bronzoro finish. Clear glass top (thickness mm. 15) with UV-glued brushed brass plate.

Runder Esstisch mit zentralem Bein aus massivem Eschenholz, befestigt auf einem Metallring mit Bronzoro Finish. Transparente Glastischplatte (15mm) mit elektrisch geschweisster Platte aus gebürstetem Messing.

Table à manger ronde avec pied central en frêne massif fixé sur un anneau en métal en finition Bronzoro. Plateau en verre transparent (épaisseur mm. 15) avec plaque en cuivre brossé soudé.

Mesa de comedor redonda con una pata central de fresno macizo montada sobre de un anillo de metal en acabado Bronzoro. Tapa de cristal transparente (espesor mm. 15) con placa pegada con UV en latón cepillado.

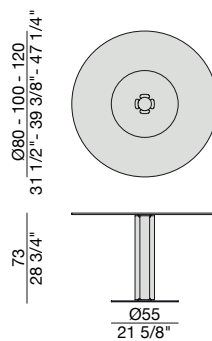

QUADRIFOGLIO TONDO 1

C. Ballabio

2018

ESSENZE | *Essences*

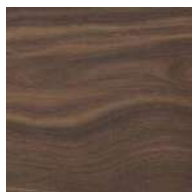

Noce Canaletta
Canaletta Walnut

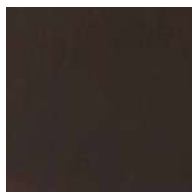

Noce Canaletta
Canaletta Walnut
tinto/stained moka

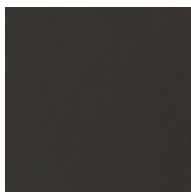

Noce Canaletta
Canaletta Walnut
tinto/stained wengé



Frassino Naturale
Natural Ash

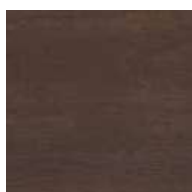

Frassino
Ash
tinto/stained moka



Frassino
Ash
*tinto noce canaletta
canaletta walnut stained*

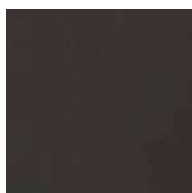

Frassino
Ash
tinto/stained wengé



Frassino
Ash
tinto/stained canapa

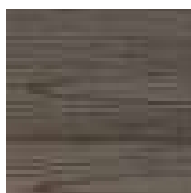

Frassino
Ash
tinto/stained caffè

QUADRIFOGLIO TONDO 1

C. Ballabio

2018

LACCATO OPACO PORO APERTO | *Matt lacquered open pore*

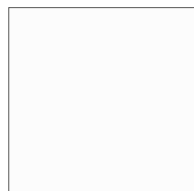

Bianco
White
(RAL 9016)

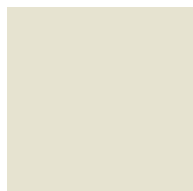

Avorio
Ivory
(RAL 1013)



Argilla
Mud
(RAL 7006)



Piombo
Lead
(NCS S5005G20Y)



Cioccolato
Chocolate
(RAL 8019)

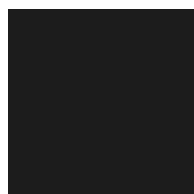

Nero
Black
(RAL 9005)



Granata
Garnet red
(NCS S4050Y90R)



Pistacchio
Pistachio green
(PANTONE 5825)



Avio
Aviation blue
(PANTONE 5415)

CRISTALLO | *Glass*

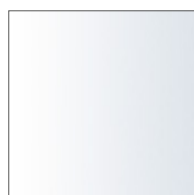

Trasparente
Transparent

METALLO | *Metal*



Ottone spazzolato
Brushed brass

QUADRIFOGLIO TONDO 3

C. Ballabio

2018

Tavolo da pranzo tondo con tre gambe e cornice del piano in massello di frassino. Inserto del piano in cristallo retroverniciato o in Rock. Piedini in ottone spazzolato.

Round dining table with three legs and top frame in solid ash. Top insert in back-coated glass or in Rock. Brushed brass feet.

Runder Esstisch mit drei Beinen und Rahmen der Tischplatte aus massivem Eschenholz. Einsätze der Tischplatte in lackiertem Glas oder in Rock in den Farben der Kollektion. Füsse aus gebürstetem Messing.

Table à manger ronde avec piétements et cadre du plateau en frêne massif. Insert du plateau en verre rétro-verni ou en Rock dans les coloris de la collection. Pieds en cuivre brossé.

Mesa de comedor redonda con tres patas y marco de la tapa de fresno macizo. Inserto de la tapa en cristal retrobarnizado o en Rock. Pies de latón cepillado.

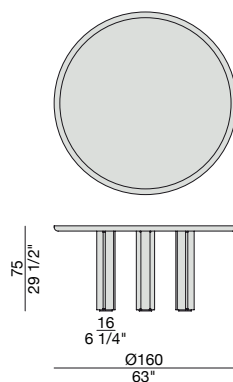

QUADRIFOGLIO TONDO 3

C. Ballabio

2018

PIANO | *Top*

Rock



Calacatta
Calacatta

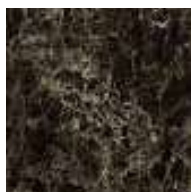

Emperador
Emperador

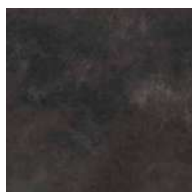

Oxide nero opaco
Matt oxide black

CRISTALLO | *Glass*

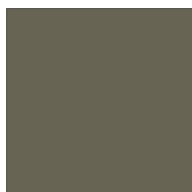

Laccato Argilla
Argilla lacquered

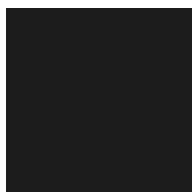

Laccato Nero
Black lacquered

METALLO | *Metal*



Ottone spazzolato
Brushed brass

QUADRIFOGLIO TONDO 3 C

C. Ballabio

2018

Tavolo da pranzo tondo con tre gambe in massello di frassino e piano in cristallo trasparente (spessore mm. 15) con piastre elettrosaldate. Piastre e piedini in ottone spazzolato.

Round dining table with three solid ash legs. Clear glass top (thickness mm. 15) with UV-glued plates. Brushed brass plates and feet.

Runder Esstisch mit drei Beinen aus massivem Eschenholz und transparenter Glastischplatte (15mm) mit elektrisch geschweißter Metallplatten. Platten und Füße aus gebürstetem Messing.

Table à manger ronde avec jambes en frêne massif et plateau en verre transparent (épaisseur mm. 15) avec plaques soudé. Plaques et pieds en cuivre brossé.

Mesa de comedor redonda con tres patas de fresno macizo. Tapa de cristal transparente (espesor mm. 15) con placas pegadas con UV. Placas y pies de latón cepillado.

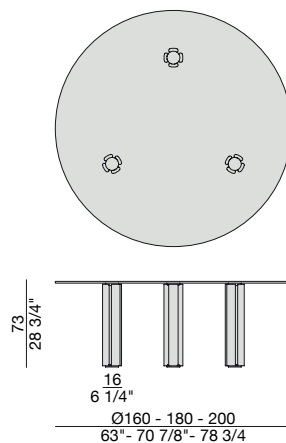

QUADRIFOGLIO TONDO 3 C

C. Ballabio

2018

ESSENZE | *Essences*

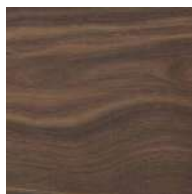

Noce Canaletta
Canaletta Walnut

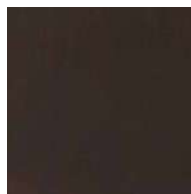

Noce Canaletta
Canaletta Walnut
tinto/stained moka

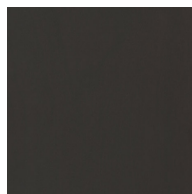

Noce Canaletta
Canaletta Walnut
tinto/stained wengé



Frassino Naturale
Natural Ash

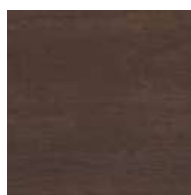

Frassino
Ash
tinto/stained moka



Frassino
Ash
*tinto noce canaletta
canaletta walnut stained*



Frassino
Ash
tinto/stained wengé



Frassino
Ash
tinto/stained canapa



Frassino
Ash
tinto/stained caffè

QUADRIFOGLIO TONDO 3 C

C. Ballabio

2018

LACCATO OPACO PORO APERTO | *Matt lacquered open pore*



Bianco
White
(RAL 9016)

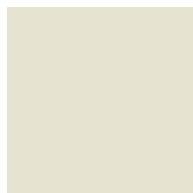

Avorio
Ivory
(RAL 1013)



Argilla
Mud
(RAL 7006)



Piombo
Lead
(NCS S5005G20Y)



Cioccolato
Chocolate
(RAL 8019)

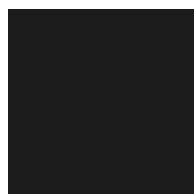

Nero
Black
(RAL 9005)



Granata
Garnet red
(NCS S4050Y90R)



Pistacchio
Pistachio green
(PANTONE 5825)

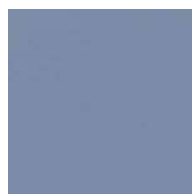

Avio
Aviation blue
(PANTONE 5415)

CRISTALLO | *Glass*

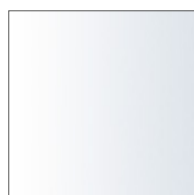

Trasparente
Transparent

METALLO | *Metal*



Ottone spazzolato
Brushed brass