



DESCRIPTION

Basic chic with an excellent, well-studied seating comfort. The combination of the broad slats and the pure but powerful design, reinvents teak in a modern, robust way. Tribù uses only the very best Javanese plantation wood for its teak outdoor furniture. Its quality is locally controlled by a subsidiary under european management to guarantee european standards.

MATERIALS

Frame: plantation teak from East-Java, every part is handpicked during the cutting process of the tree. The slats have a thickness of 2cm.

CUSHIONS

Filling in dryfoam which has an open cell structure, so air can circulate freely. Water passes through the filling, but dries quickly thanks to the large open pores, substantially inhibiting fungal growth. Fabrics available in category D, E & F. The cushions of the Kos collection have an overstitched pattern.



COLOURS

Teak



KOS

TECHNICAL DRAWINGS

04018 - Armchair

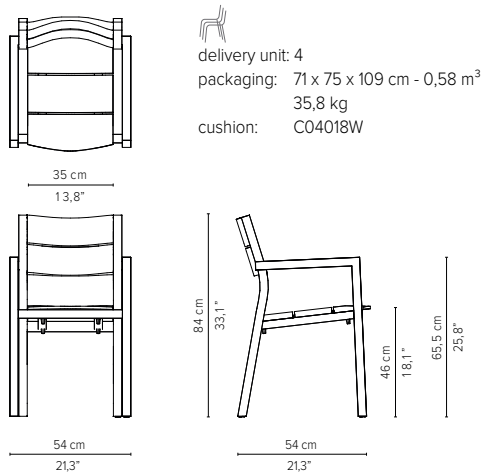

04034 - Bench 196 cm 

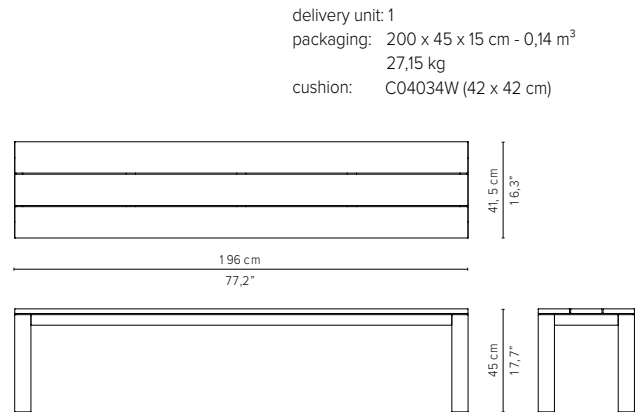

04012 - Easy chair

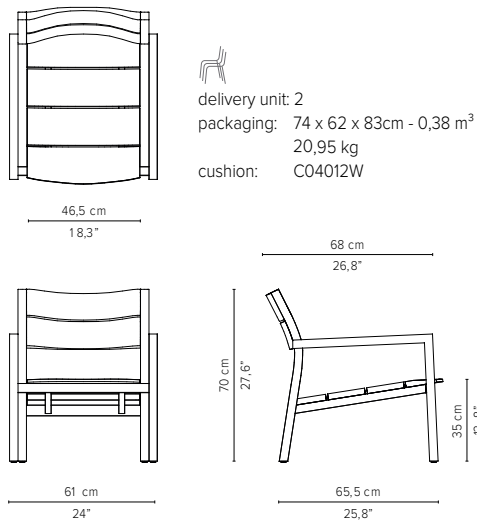

04016 - Barchair

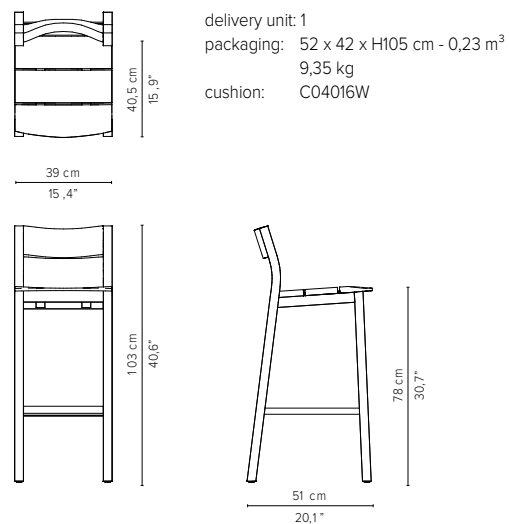

04090 - Footrest / Sidetable

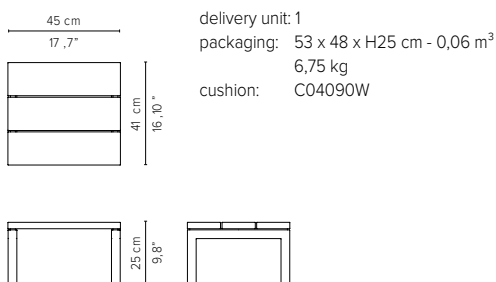

Appearances, measurements and weights may slightly differ from reality.

KOS

TECHNICAL DRAWINGS

04070 - Dining table 83 x 83 cm

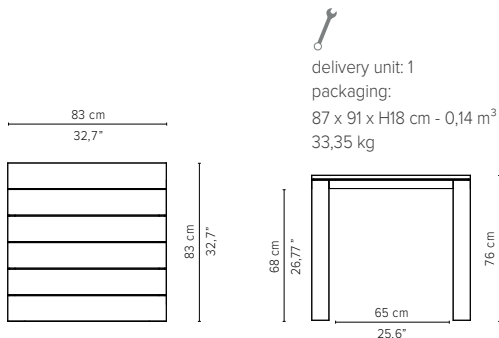

04073 - Dining table 100 x 100 cm

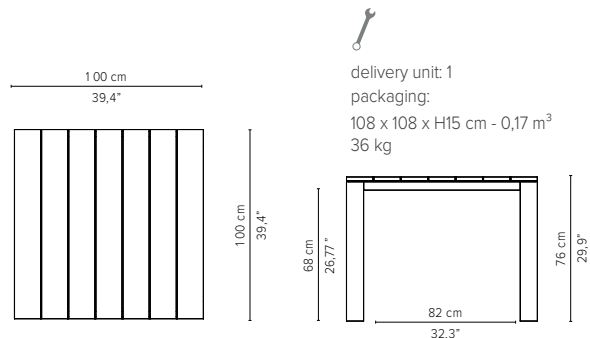

04052 - Dining table 223 x 100 cm

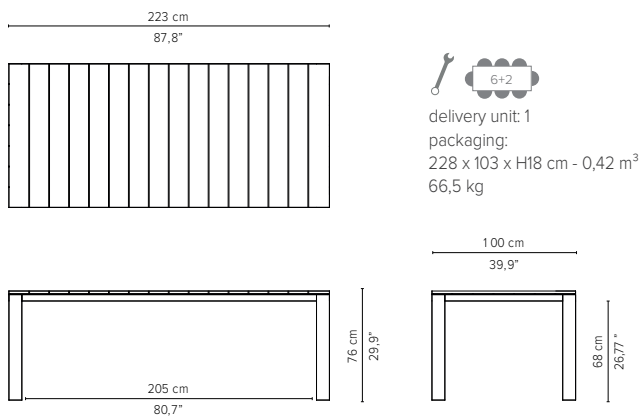

04053 - Dining table 265 x 100 cm

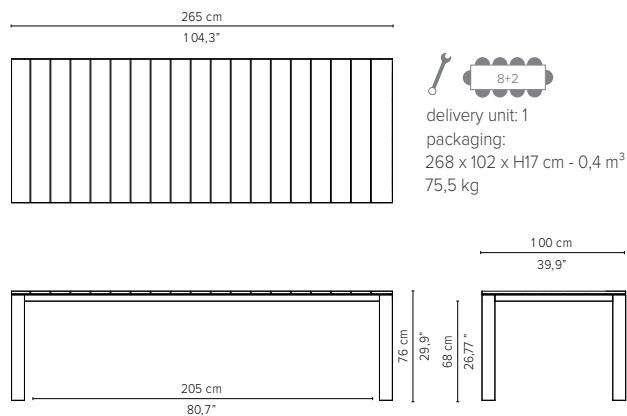

04054 - Dining table 308 x 110 cm

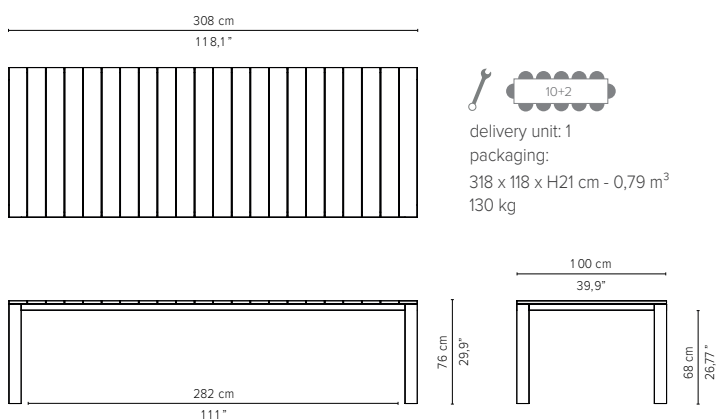

04060 - Foldable table

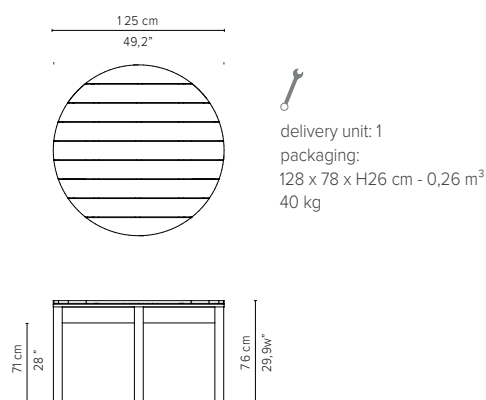

Appearances, measurements and weights may slightly differ from reality.

KOS

TECHNICAL DRAWINGS

04040 - Adjustable Lounger

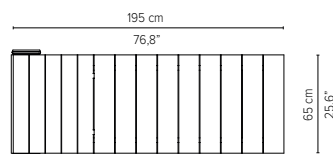

delivery unit: 1
packaging:
198 x 71 x H26 cm - 0,37 m³
36,5 kg
Cushion: C04040W - 0,07 m³



01340-74 - Adjustable Lounger Batyline

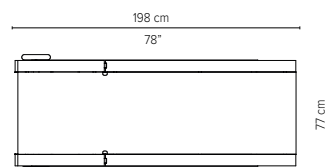

delivery unit: 1
packaging:
205 x 80 x H37 cm - 0,61 m³
37 kg
Batyline: 74 - Quartz

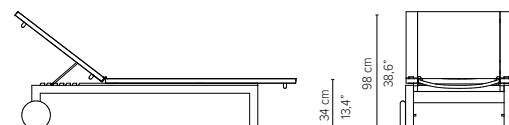

Appearances, measurements and weights may slightly differ from reality.

KOS

PROTECTION COVERS

For each item a cover is available that protects the furniture against dirt. These covers in grey colour are made of PU coated polyester which is water-repellent and UV-resistant. Thanks to their excellent breathable qualities the covers reduce condensation and heat build-up, helping to prevent the formation of mold and mildew. Always make sure that furniture, cushions and covers are completely dry before covering furniture.

MAINTENANCE

Teak

Treat new teak with Teak Protector 4 à 6 weeks after installation. Teak Protector applies an invisible film that prevents stains and green deposit. Soiled teak can be cleaned with Teak Super Cleaner. Leave the furniture to dry completely and then apply Teak Protector. To avoid labour-intensive cleaning, you can treat the wood with Teak Sealer. A simple cleaning with water and a ph-neutral soap will do for many years. Teak Sealer contains UV protection to slow down the graying from the sun as well as a fungicide to prevent the growth of mold and mildew.



D9914
Teak Super
Cleaner



D9912
Teak Protector



D9959
Teak Sealer

KOS

TECHNICAL STANDARDS

04018 Armchair

ANSI/BIFMA X5.1-2011

EN1022:2005 6
EN581-1:2006 5
EN 1728:2012

CPSD-HL-01063-MTHD
CPSD-HL-01012-MTHD



04012 Easy chair

ANSI/BIFMA X5.1-2011

EN1022:2005 6
EN581-1:2006 5
EN 1728:2012

CPSD-HL-01063-MTHD
CPSD-HL-01012-MTHD



04040 Lounger

ANSI/BIFMA X5.4-2012

CPSD-HL-01063-MTHD
CPSD-HL-01012-MTHD



KOS

PROJECT REFERENCES



Spa at Hard Rock Hotel, Ibiza – Kos armchair, bench and dining chair



Spa at Hard Rock Hotel, Ibiza – Kos lounge



Radisson Blu Iveria, Tbilisi – Kos lounge