

# Grant — Tristan Auer — 2019 / 2020

---



Tristan Auer disegna per Poltrona Frau una collezione di pouf dall'eleganza nomade, versatile e trasversale: le sedute Grant vivono con la stessa disinvoltura negli spazi pubblici o residenziali, singolarmente o accostate in combinazioni personalizzabili.

## CARATTERISTICHE TECNICHE

---

### Modelli.

- Pouf 60×40 De Luxe
- Pouf 65×45 De Luxe con contenitore
- Pouf ø46 De Luxe
- Pouf 90×64 De Luxe
- Pouf 140×80
  - tipo A De Luxe
  - tipo B De Luxe
  - tipo B De Luxe con braccioli
  - tipo B
  - tipo B con braccioli
- Pouf 110×110
  - tipo A De Luxe
  - tipo B De Luxe
  - tipo B

## CARATTERISTICHE COMUNI A TUTTI I MODELLI

---

**Struttura.** In multistrato di betulla.

**Imbottitura.** Seduta e fianchi sono imbottiti in poliuretano espanso. Nel pouf ø46 De Luxe l'imbottitura è rinforzata da una tela elastica che assicura il molleggio.

**Zoccolo inferiore.** In MDF verniciato nero testurizzato con puntali in plastica nera a protezione del pavimento.

**Dettagli estetici (eccetto Pouf De Luxe: 60×40, 65×45 con contenitore, ø46 e 90×64).** Due cinte decorative avvolgono verticalmente la struttura del pouf. Alla base delle cinte sono poste delle fibbie in acciaio con trattamento galvanico ruthenium.

## MODELLI DE LUXE

---

I modelli sono caratterizzati da una particolare lavorazione a intreccio, realizzata con fasce in Pelle Frau® larghe 6 cm a 45°, che decora la struttura perimetrale dei pouf.

**Rivestimento.** Nei modelli De Luxe il rivestimento in pelle è disponibile solo nelle seguenti pelli:

- ColorSphere® (SC)
- Soul

**Sfoderabilità.** Non prevista.

Pouf 65×45 De Luxe con contenitore

Tristan Auer has designed a collection of poufs for Poltrona Frau which stand out for their nomadic, versatile and flexible elegance: the Grant seats are equally at home in public and residential settings, on their own or in bespoke combinations.

## TECHNICAL FEATURES

---

### Items.

- 60×40 De Luxe Ottoman
- 65×45 De Luxe Ottoman with storage compartment
- ø46 De Luxe Ottoman
- 90×64 De Luxe Ottoman
- 140×80 Ottoman
  - type A De Luxe
  - type B De Luxe
  - type B De Luxe with armrests
  - type B
  - type B with armrests
- 110×110 Ottoman
  - type A De Luxe
  - type B De Luxe
  - type B

## FEATURES COMMON TO ALL ITEMS

---

**Structure.** Made of birch plywood.

**Padding.** The seat and sides are padded with polyurethane foam. In the ø46 De Luxe Ottoman the padding is reinforced with an elastic cloth to secure the springs.

**Lower base.** In MDF in texturised black paint with black plastic caps to protect the floor.

**Aesthetic details (except for the De Luxe Ottomans: 60×40 65×45 with storage compartment, ø46 and 90×64).** Two decorative belts are wrapped vertically around the frame of the ottoman. At the base of the belts there are steel buckles with ruthenium galvanic treatment.

## DE LUXE ITEMS

---

The items are distinctive for their original latticework - consisting of 6 cm-wide strips of handwoven Pelle Frau® leather at a 45° angle - which decorates the perimetral upholstery of the ottomans.

**Upholstery.** In the De Luxe items, the leather upholstery is only available in the following leathers:

- ColorSphere® (SC)
- Soul

**Removability.** Not possible.

65×45 De Luxe Ottoman with storage compartment

---

**Vano contenitore.** Rivestito in tessuto tecnico di colore nero. Il meccanismo di apertura è dotato di un sistema che blocca il coperchio in posizione quando aperto e ne ammortizza la chiusura.

**Coperchio seduta.** Realizzato in multistrato di betulla.

#### POUF TIPO "A"

##### Configurazioni disponibili.

- Pouf 140×80
- Pouf 110×110

Sono disponibili solo nella versione De Luxe e sono caratterizzati da una base alta, sempre rivestita in pelle con lavorazione ad intreccio, e da un cuscino seduta basso rivestibile in pelle o in tessuto.

**Rivestimento.** In Pelle Frau® o nell'abbinamento della pelle con il tessuto. La base è sempre rivestita in pelle con particolare lavorazione a intreccio, mentre il cuscino seduta può essere in pelle liscia abbinata o in tessuto.

- ColorSphere® (SC)
- ColorSphere® (SC) / Fabric A
- ColorSphere® (SC) / Fabric B
- ColorSphere® (SC) / COM
- Soul
- Soul / Fabric A
- Soul / Fabric B
- Soul / COM

**Sfoderabilità.** Non prevista.

**Cinte decorative.** Sono realizzate in Pelle Frau® in abbinamento al rivestimento della base e scompaiono sotto il cuscino seduta.

#### POUF TIPO "B"

##### Configurazioni disponibili.

- Pouf 140×80
- Pouf 140×80 con braccioli
- Pouf 110×110

Sono caratterizzati da una base bassa, sempre rivestita in pelle e da un cuscino seduta alto in tessuto o, nella versione De Luxe, in pelle con rivestimento perimetrale realizzato con caratteristica lavorazione a intreccio e superficie della seduta sempre in pelle liscia abbinata.

**Rivestimento.** Interamente in Pelle Frau® (sia le parti con lavorazione a intreccio che in pelle liscia) o nell'opzione che abbinata pelle e tessuto. In questo caso la base è rivestita in pelle e il cuscino seduta e le cinte decorative in tessuto.

- ColorSphere® (SC)
- Soul
- Fabric A / ColorSphere® (SC)
- Fabric A / Nest
- Fabric A / Soul
- Fabric A / Century
- Fabric B / ColorSphere® (SC)
- Fabric B / Nest
- Fabric B / Soul
- Fabric B / Century
- C.O.M. / ColorSphere® (SC)
- C.O.M. / Nest
- C.O.M. / Soul
- C.O.M. / Century

**Sfoderabilità.** Non prevista.

**Cinte decorative (pouf senza braccioli).** Sono realizzate in Pelle Frau® o in tessuto in abbinamento al rivestimento del cuscino seduta.

**Braccioli.** I pouf 140×80 di tipo B sono disponibili

**Storage compartment.** Covered in black technical fabric. The opening mechanism is equipped with a system that locks the lid in the open position and softens its closure.

**Seat lid.** Made from birch plywood.

#### TYPE "A" OTTOMAN

##### Available configurations.

- 140×80 Ottoman
- 110×110 Ottoman

Available only in the De Luxe version, they have a high base, upholstered in leather with latticework, and a low seat cushion that can be covered in leather or fabric.

**Upholstery.** In Pelle Frau® leather or a combination of leather and fabric. The base is always covered in leather with distinctive latticework, while the seat cushion can be in smooth matching leather or fabric.

- ColorSphere® (SC)
- ColorSphere® (SC) / Fabric A
- ColorSphere® (SC) / Fabric B
- ColorSphere® (SC) / COM
- Soul
- Soul / Fabric A
- Soul / Fabric B
- Soul / COM

**Removability.** Not possible.

**Decorative belts.** Made from Pelle Frau® leather matching the upholstery of the base, they disappear under the seat cushion.

#### TYPE "B" OTTOMAN

##### Available configurations.

- 140×80 Ottoman
- 140×80 Ottoman with armrests
- 110×110 Ottoman

They have a low base upholstered in leather and a high seat cushion in fabric or, in the De Luxe version, in leather with external cover with distinctive latticework, and a seat surface always in smooth matching leather.

**Upholstery.** Entirely in Pelle Frau® leather (both the smooth parts and the parts with latticework) or in leather / fabric combination. In this case the base is upholstered in leather while the seat cushion and the decorative belts in fabric.

- ColorSphere® (SC)
- Soul
- Fabric A / ColorSphere® (SC)
- Fabric A / Nest
- Fabric A / Soul
- Fabric A / Century
- Fabric B / ColorSphere® (SC)
- Fabric B / Nest
- Fabric B / Soul
- Fabric B / Century
- C.O.M. / ColorSphere® (SC)
- C.O.M. / Nest
- C.O.M. / Soul
- C.O.M. / Century

**Removable cover.** Not possible.

**Decorative belts (ottoman without armrests).** Made from Pelle Frau® leather or fabric matching the upholstery of the seat cushion.

**Armrests.** Type B 140×80 ottomans are available

- con kit braccioli composto da due coppie di cuscini rettangolari agganciati alle cinte decorative (imbottiti in poliuretano espanso)
- senza braccioli

---

**Cinte decorative e braccioli.** In questo caso le cinte avvolgono la seduta e sono dotate di bottoni automatici per bloccare i cuscini bracciolo.

Il rivestimento di cinte e cuscini è, a scelta, in pelle o in tessuto in abbinamento alla base o al cuscino seduta.

- ColorSphere® (SC)
- Nest
- Soul
- Century
- Fabric A\*
- Fabric B\*
- C.O.M.

\* Sono disponibili anche i tessuti Kvadrat

**N.B. In caso di rivestimento in sola Pelle Frau® (modelli De Luxe) le cinte e i cuscini saranno rivestibili o in tessuto (scelta libera) o nella stessa pelle specificata per il pouf.**

---

**Dettagli estetici.** Un filetto in pelle delimita la seduta ed è sempre abbinato al rivestimento della base.

- with an armrest kit, which consists of two pairs of rectangular cushions attached to the decorative belts (padded in polyurethane foam)
- without armrests

---

**Decorative belts and armrests.** In this case the belts wrap around the seat and come with snap buttons to hold the armrest cushions in place. The belts and cushions can be upholstered in leather or fabric matching the base or seat cushion.

- ColorSphere® (SC)
- Nest
- Soul
- Century
- Fabric A\*
- Fabric B\*
- C.O.M.

\* Kvadrat fabrics also available

**N.B. Where the upholstery is only in Pelle Frau® leather (De Luxe items) the belts and cushions can be upholstered in fabric (free choice) or in the same leather specified for the ottoman.**

---

**Aesthetic details.** A leather trim matching the cover of the base frames the seat.

---

**TIPOLOGIE DISPONIBILI / AVAILABLE TYPOLOGIES**



---

**TIPO A / TYPE A**

SOLO VERSIONE "DE LUXE" / ONLY IN THE "DE LUXE" VERSION

base alta in pelle intrecciata  
*woven leather high base*

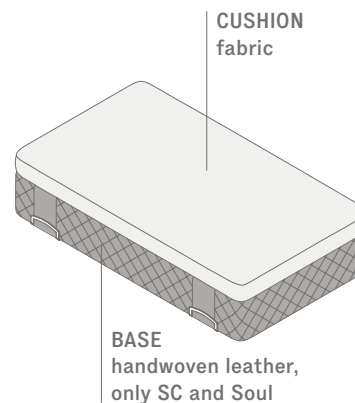
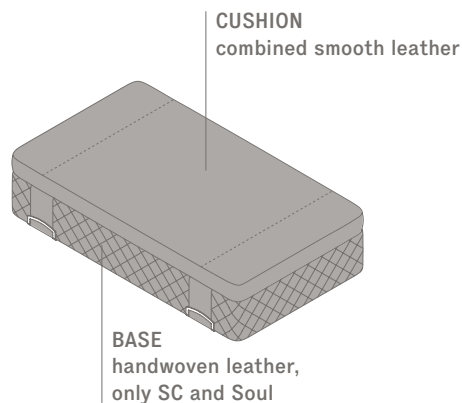
+

cuscino seduta basso in pelle o in tessuto  
*low seat cushion in leather or fabric***TIPO B / TYPE B**base bassa in pelle  
*low base in leather*

+

cuscino seduta alto in pelle (con rivestimento perimetrale in pelle intrecciata) o in tessuto  
*high seat cushion in leather (with handwoven leather perimetral upholstery) or in fabric*



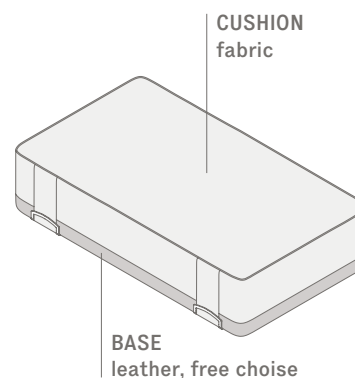
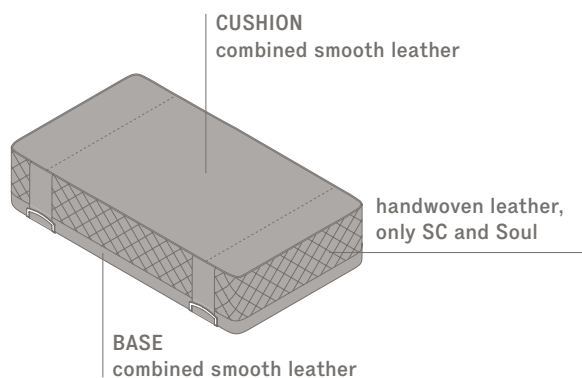

## DE LUXE VERSION

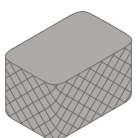
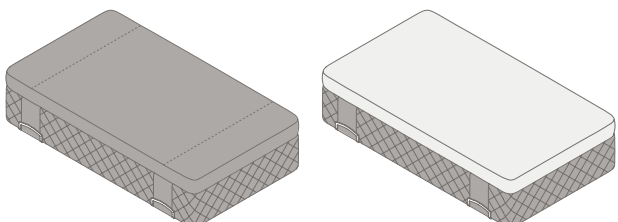
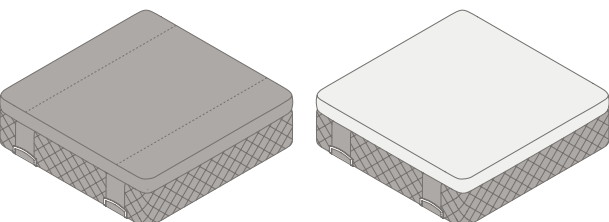
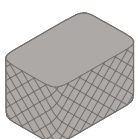
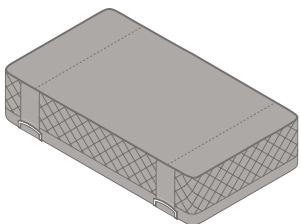
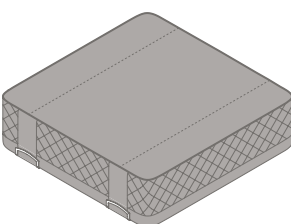
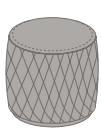
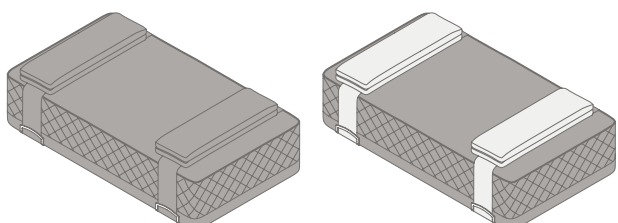
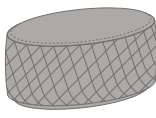
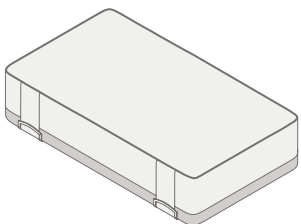
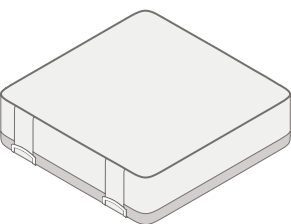
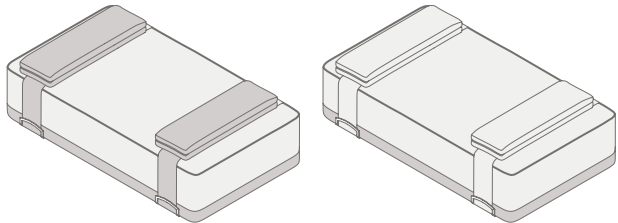

N.B.: i disegni si riferiscono alla misura 140×80 ma le stesse regole sono applicabili anche ai pouf 110×110  
Please note: drawings refer to the 140×80 size but the same rules are valid for 110×110 ottomans

---

REGOLE APPLICAZIONE RIVESTIMENTI / UPHOLSTERY APPLICATION RULES

OTTOMAN DE LUXE	RECTANGULAR OTTOMAN 140X80	SQUARE OTTOMAN 110X110
<p>5648511 OTTOMAN 60X40 DE LUXE</p> 	<p>5648531 OTTOMAN 140X80 DE LUXE TYPE A</p> 	<p>5648541 OTTOMAN 110X110 DE LUXE TYPE A</p> 
<p>5648512 OTTOMAN 65X45 DE LUXE</p> 	<p>5648532 OTTOMAN 140X80 DE LUXE TYPE B</p> 	<p>5648542 OTTOMAN 110X110 DE LUXE TYPE B</p> 
<p>5648551 OTTOMAN Ø46 DE LUXE</p> 	<p>5648533 OTTOMAN 140X80 DE LUXE TYPE B WITH ARMS</p> 	
<p>5648552 OTTOMAN 90X64 DE LUXE</p> 	<p>5648534 OTTOMAN 140X80 TYPE B</p> 	<p>5648543 OTTOMAN 110X110 TYPE B</p> 
	<p>5648535 OTTOMAN 140X80 TYPE B WITH ARMS</p> 	<p>  Fabric (A, B, C.O.M.)   Pelle Frau® SC / Soul   Pelle Frau® (libera scelta / free choice)         </p>

Complementi e Accessori  
 Complementary units, Accessories

5648511

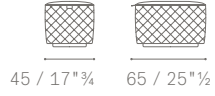
42 / 16<sup>1</sup>/<sub>2</sub>"

5648512

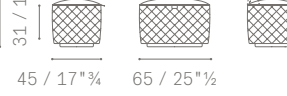
44 / 17<sup>1</sup>/<sub>4</sub>"  
75 / 29<sup>1</sup>/<sub>2</sub>"  
31 / 12<sup>1</sup>/<sub>4</sub>"

5648551



46 / 18"

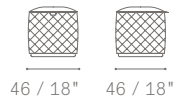

5648552

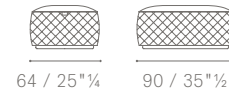
40 / 15<sup>3</sup>/<sub>4</sub>"

5648531



Pelle Frau® upholstery



Fabric upholstery

38 / 15"

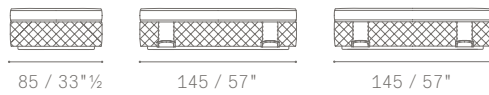

5648532



38 / 15"

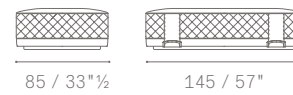

5648533

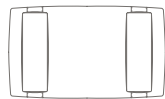
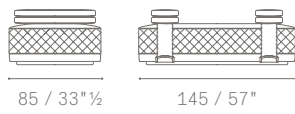
51 / 20"  
38 / 15"

5648534



38 / 15"

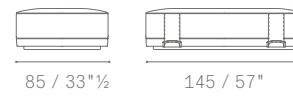

5648535

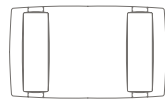
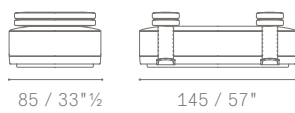
51 / 20"  
38 / 15"

5648541

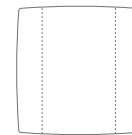

Pelle Frau® upholstery

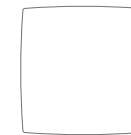

Fabric upholstery

38 / 15"

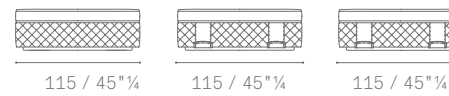

5648542

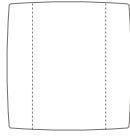

38 / 15"



115 / 45"¼



115 / 45"¼

5648543

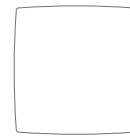

38 / 15"

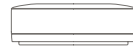

115 / 45"¼

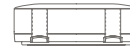

115 / 45"¼