

ERMES

MAURO LIPPARINI



A reinterpretation of the wraparound design of the **Ermes** chair with the use of special color and material choices. The usual craftsmanship for every little detail highlights the unusual combinations, emphasizing the aesthetic qualities of the product. Full shapes create an intimate dimension, an invitation to relax.

TYPE / ARMCHAIRS

TECHNICAL DESCRIPTION

Armchairs and pouf with cold-foamed polyurethane frame, available in three versions: wood fixed base in solid oak, swivel base in satined stainless steel, metal base with fabric cover. Cover in fabric, ecoleather or leather. It is available the bicolor variant with different finishings for both the front upholstery and the back one.



DESIGNER

MAURO LIPPARINI

Mauro Lipparini earned a degree in Architecture in 1980 from Università degli Studi di Firenze, where he also worked as a professor. He won the international design contests Young & Designer Milan (1987) and International Du Pont Award Köln (Germany, 1988 and 1989). Lipparini's intense activity in the field of industrial design covers office and home furniture, the textile industry and other products created for many companies in Europe and Japan. In architecture and interior design, Lipparini has concentrated mainly on private and public housing, on showrooms, retail sales outlets and exposition installations. Furthermore, Lipparini also designs and realizes advanced corporate identity image systems that range from graphics to editorial services to production. Lipparini's style is based on the essential shapes and the clear and decisive lines that are characteristic of natural minimalism. His creations are imbued with a joyful spirit and with an elating sense of aesthetic pleasure and creativity. Thanks to his free use of color, organic weave patterns and original visual ideas, Lipparini amplifies the palette of minimalism, conveying the spontaneity and power of this aesthetic style and projecting it towards a new era of great maturity and wellbeing.



COVER FINISHINGS

FABRICS

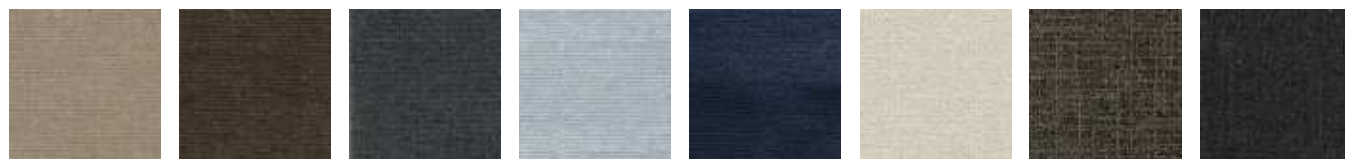

A_AS1 Saari A_AS2 Saari A_AS4 Saari A_AS5 Saari A_AS7 Saari B_CAE Cocò B_CAM Cocò B_CAK Cocò



B_CAF Cocò B_BC1 Burana B_BC3 Burana B_BC4 Burana B_BC6 Burana C_C10 Star C_C11 Star C_C17 Star



C_C16 Star C_C18 Star C_C15 Star D_D91 Panama D_D92 Panama D_D93 Panama D_D94 Panama D_D95 Panama



D_D98 Panama D_i71 Clou D_i74 Clou D_i79 Clou D_i72 Clou D_i78 Clou D_D01 Ubaye D_D03 Ubaye



D_D05 Ubaye E_E20 Mood E_E25 Mood E_E22 Mood E_E26 Mood E_E27 Mood E_E21 Mood E_E28 Mood



E_E51 Lido E_E52 Lido E_E54 Lido F_E50 Luxus F_F01 Luxus F_F02 Luxus F_F03 Luxus F_F05 Luxus

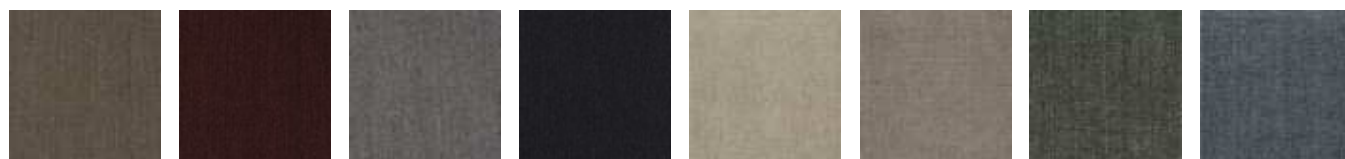

F_F11 Lama F_F14 Lama F_F12 Lama F_F15 Lama F_F25 Gaucho F_F21 Gaucho F_F23 Gaucho F_F24 Gaucho



F_F33
Velvet

F_F35
Velvet

F_F32
Velvet

F_EM5
Velvet

H_H42 Sera

H_H44 Sera

H_H47 Sera

H_H48 Sera

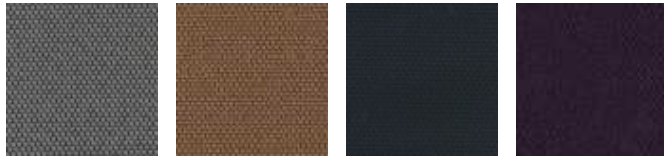

H_H50
Opera

H_H53
Opera

H_H55
Opera

H_H56
Opera

SMOOTH LEATHERS



H30 Gesso

H38 Sand

H36
Camoscio

H32 Acacia

H31
Naturale

H37
Marmotta

H71 Testa di
Moro

H35 Grigio
Chiaro



H40 Blu
Notte

H73 Nero

NUBUCK



HN2
Carbone

HN3 Grigio

SMOOTH ECO-LEATHERS



C_CE1

C_CD3

C_CF6

C_CD1

C_CD4

C_CD5

EMBOSSSED ECO-LEATHERS

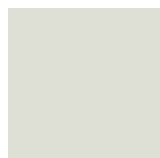

C_CE3

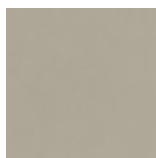

C_CE5



C_CL1



C_CL3

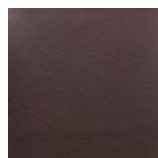

C_CL7

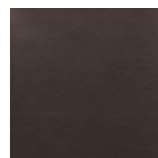

C_CL8

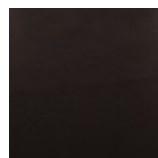

C_CL6

BACK FINISHINGS (BICOLOR VERSION)

FABRICS



A_AS1 Saari



A_AS2 Saari



A_AS4 Saari



A_AS5 Saari



A_AS7 Saari



B_CAE Cocò



B_CAM
Cocò



B_CAK Cocò



B_CAF Cocò



B_BC1
Burana



B_BC3
Burana



B_BC4
Burana



B_BC6
Burana



C_C10 Star



C_C11 Star



C_C17 Star



C_C16 Star



C_C18 Star



C_C15 Star



D_D91
Panama



D_D92
Panama



D_D93
Panama



D_D94
Panama



D_D95
Panama

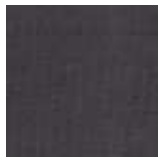

D_D98
Panama



D_i71 Clou



D_i74 Clou



D_i79 Clou



D_i72 Clou



D_i78 Clou



D_D01
Ubaye



D_D03
Ubaye



D_D05
Ubaye



E_E20 Mood



E_E25 Mood



E_E22 Mood



E_E26 Mood



E_E27 Mood



E_E21 Mood



E_E28 Mood



E_E51 Lido



E_E52 Lido



E_E54 Lido



F_F50 Luxus



F_F01 Luxus



F_F02 Luxus



F_F03 Luxus



F_F05 Luxus



F_F11 Lama



F_F14 Lama



F_F12 Lama



F_F15 Lama



F_F25
Gaucho



F_F21
Gaucho



F_F23
Gaucho



F_F24
Gaucho



F_F33
Velvet

F_F35
Velvet

F_F32
Velvet

F_EM5
Velvet

H_H42 Sera

H_H44 Sera

H_H47 Sera

H_H48 Sera

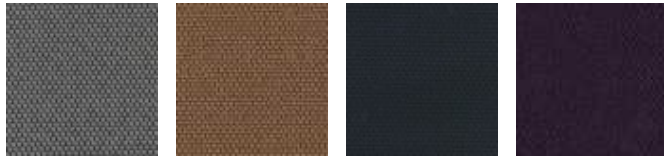

H_H50
Opera

H_H53
Opera

H_H55
Opera

H_H56
Opera

SMOOTH LEATHERS



H30 Gesso

H38 Sand

H36
Camoscio

H32 Acacia

H31
Naturale

H37
Marmotta

H71 Testa di
Moro

H35 Grigio
Chiaro



H40 Blu
Notte

H73 Nero

SUEDE LEATHERS

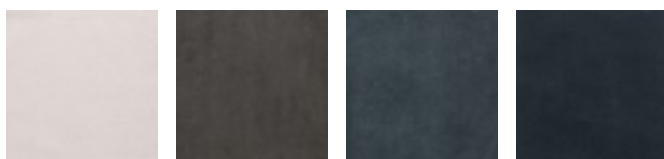

HA6 Neve

HA5
Marmotta

HA2 Nuvola

HA3 Blu

PRINTED LEATHERS

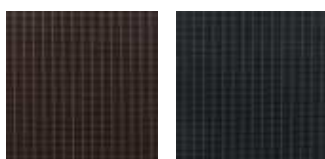

HV2
Marrone

HV1 Nero

NUBUCK



HN2
Carbone

HN3 Grigio

SMOOTH ECO-LEATHERS



C_CE1

C_CD3

C_CF6

C_CD1

C_CD4

C_CD5

EMBOSSSED ECO-LEATHERS



C_CE3

C_CE5

C_CL1

C_CL3

C_CL7

C_CL8

C_CL6

BASE FINISHINGS

METALS



522 Satinato

MATT VENEERS



53 Olmo
grey



50 Rovere
cenere



52 Rovere
fumé

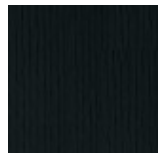

51 Oak
Black

DIMENSIONS

Wood fixed base

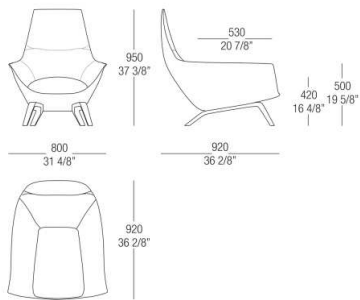

Metal swivel base

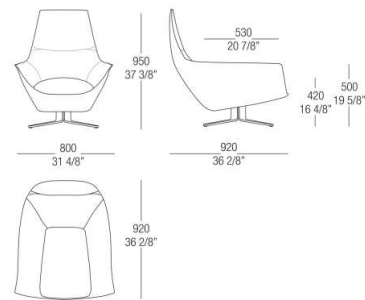

Vesta

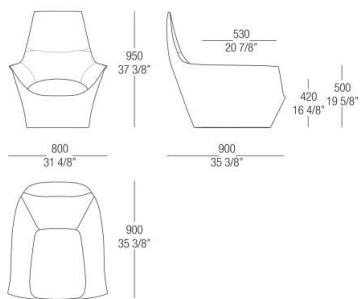

Pouf

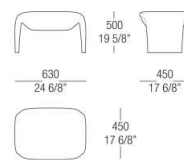

Lower back support cushion

