

Club armchair bela rope aluminium

Designer
Rodolfo Dordoni

Collection
Bitta

Reference
KS7000300

1/5

Kettal Bitta is characterised by a combination of aluminium frames, seats of braided polyester and comfortable cushions, teak and stone for the table tops. My aim was to create dense braiding that would still let the air through, reminiscent of the braiding of the ropes used to moor boats (hence the name Bitta, which means 'mooring' in Italian), which makes the pieces look lightweight but, at the same time, they look just like cosy nests in natural colours to sit back and relax in.

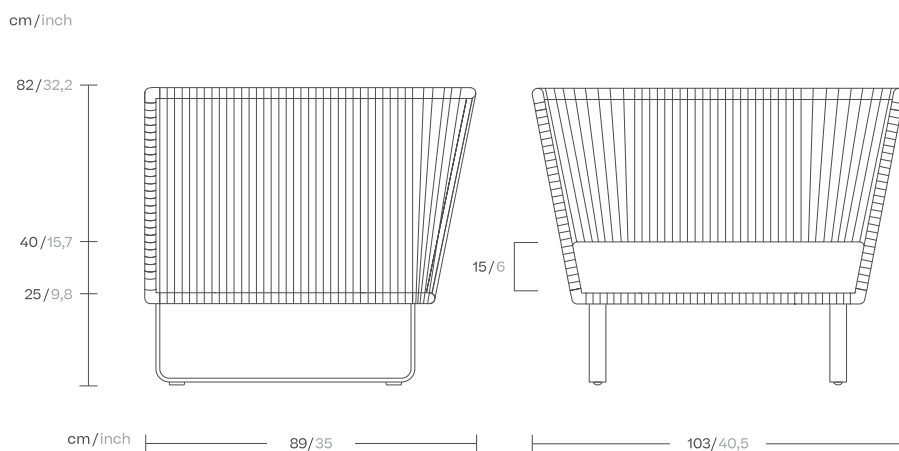

kettal

Club armchair bela rope teak

Designer
Rodolfo Dordoni

Collection
Bitta

Reference
KS7000300

1/5

Kettal Bitta is characterised by a combination of aluminium frames, seats of braided polyester and comfortable cushions, teak and stone for the table tops. My aim was to create dense braiding that would still let the air through, reminiscent of the braiding of the ropes used to moor boats (hence the name Bitta, which means 'mooring' in Italian), which makes the pieces look lightweight but, at the same time, they look just like cosy nests in natural colours to sit back and relax in.

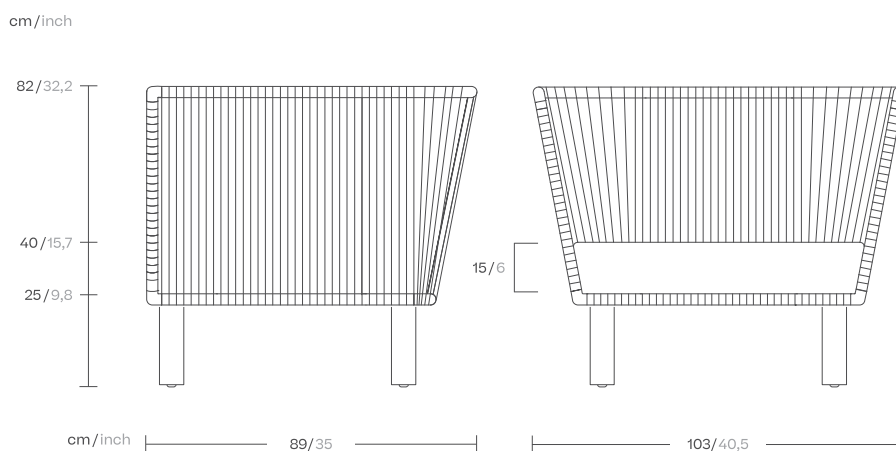

kettal

Club armchair bela rope teak

Designer
Rodolfo Dordoni

Collection
Bitta

Reference
KS7000300

2/5

Materials

Rope

Antioxy, Resist UV, En-581-4, Easy Clean

Fabric

Heavy Load 100.000 Cycles, Heavy Load Resistant 1000 Decitex, Kettalize-It, Resist U.v. En-581-4, Easy Clean, Abrasion, Resistance 30.000 Cycles, Quickdry

Aluminium

Antioxy, Heavy Load, Resistant En-1421, Anti-Scratch, Easy Clean, Flame Retardant M1, Eco Friendly Ecoembes Recycling Process Foam UNI 9175 (Classe 1IM), Anti-Mold, Flame Retardant M1

Teak

Teak A-Grade, Eco Friendly Oeko-Tek

Maintenance

Clean with mild soap using sponge or cloth. Be gentle while cleaning, do not scrub aggressively the fabric. Once cleaned please make sure you remove soap excess.

In case of aggressive stains clean with diluted household bleach.

Clean stains promptly. The longer it remains, more difficult will be to remove.

Once cleaned the fabric steam iron the fabric. Just use steam, be carefull NOT placing the iron directly in the fabric it will get damage.

Legs Colour Options

Terrain Paints (for Aluminium)



Chalk
721



Bone
678



Tuff
103



Mist
773



Flint
734



London Clay
729



Mahogany
100



Carbon
737



Lilac
104



Feldspar
082



Sepia
088



Terra Rossa
087



Magma
086



Terracota
085



Sahara
139



Camomile
106



Aquamarine
107



Cobalt
089



Indigo
094



Jade
091



Onyx
101



Juniper
092

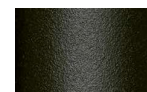

Amazon
102

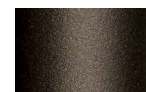

Bronze
093

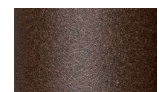

Corten
727



Claystone
741



Sand Storm
132



Pumice
131



Galena
105



Manganese
726

Legs Colour Options

Teak



Teak
904

Club armchair bela rope teak

Designer
Rodolfo Dordoni

Collection
Bitta

Reference
KS7000300

3/5

Frame Colour Options

Bela Rope



Snow Bird
434



Silver Leaf
421



Woodland
441



New Dawn
452

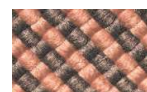

Honeysuckle
453



Forest Bell
451



Jasmine
431

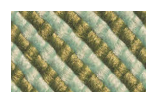

Oberon
432



Ivy
433



Esmerald
425



Blue River
422



Alpina
423



Romantika
424



Wisteria
414



Rosa
413



Campsis
411



Virginia
412

Club armchair bela rope teak

Designer
Rodolfo Dordoni

Collection
Bitta

Reference
KS7000300

4/5

Seat & Back Cushion

Terrain Fabrics

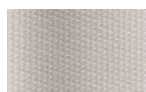

White Cliffs
290



Dry Sand
285



Porous Grey
291



Limestone
292



Fog
289



Deer
286

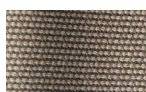

Wet Sand
287



Cobblestone
302



Cyprus Umber
301



Loam
297



Charcoal
293



Arctic
295



Fjord
248



Cerulean
314



Caribbean
298



Atlantic
311



Rainforest
312



Lagoon
249



Cedar
288



Moss
296



Olive
313



Autumn
315

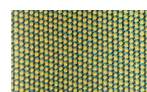

Summer Sky
317



Golden Sand
303



Flamma
304



Sunrise
299



Saffron
305



Burnt Sienna
306

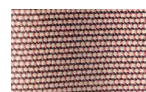

Ash Rose
294



Cooper
316



Dusk Pink
307



Flamingo
310



Coral
309



Sandstone
308

Club armchair bela rope teak

Designer
Rodolfo Dordoni

Collection
Bitta

Reference
KS7000300

5/5

Back Cushion

Geometric Fabrics

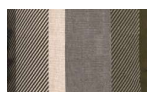

Umbra Brown
192



Dash Brown
162



Shade Brown
152



Dots Brown
142



Dots Light Brown
147



Umbra Green
191



Dash Green
161



Shade Green
151

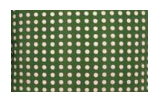

Dots Green
141



Dots Light Green
146

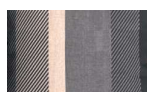

Umbra Grey
193



Dash Grey
163



Shade Grey
153

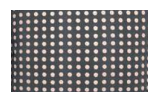

Dots Grey
143



Dots Light Grey
148



Umbra Blue
190



Dash Blue
160



Shade Blue
150



Dots Blue
140



Dots Light Blue
145



Umbra Red
194



Dash Red
164



Shade Red
154



Dots Red
144

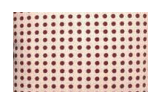

Dots Light Red
149