



DESCRIZIONE

Tipologia	Madia
Struttura	Pannello di particelle di legno impiallacciato
Top	Pannello di particelle di legno impiallacciato o marmo
Piedi	Alluminio verniciato
Ripiani	Vetro
Struttura cassetti	Pannello di particelle di legno nobilitato

DIMENSIONI

Due ante battenti, un cassetto e un vano a giorno

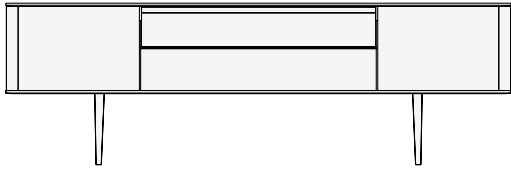

2128
83 3/4"

680
26 3/4"

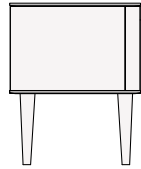

548
21 1/2"

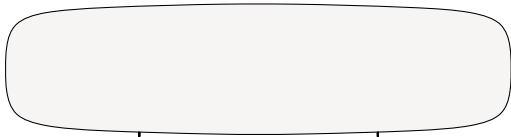

Due ante battenti e due cassetti

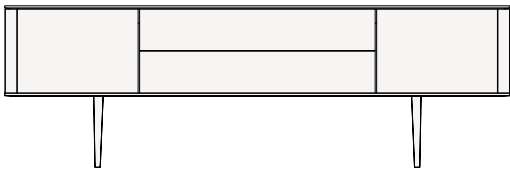

2128
83 3/4"

680
26 3/4"

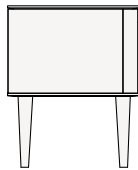

548
21 1/2"

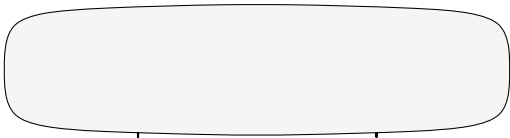

Due ante battenti e tre cassetti

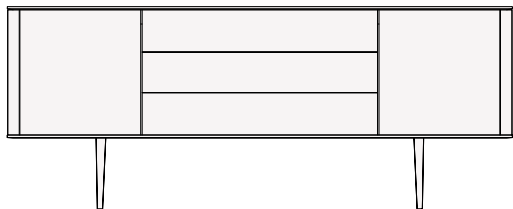

2128
83 3/4"

855
33 3/4"

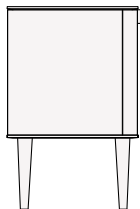

548
21 1/2"

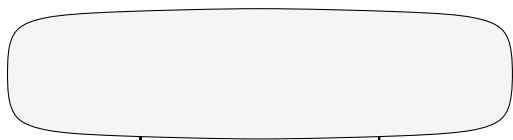

Due ante battenti

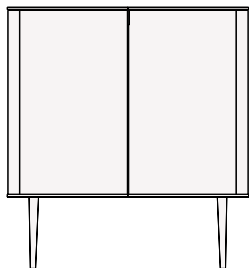

1018
40"

1100
43 1/4"

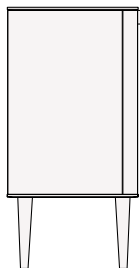

548
21 1/2"

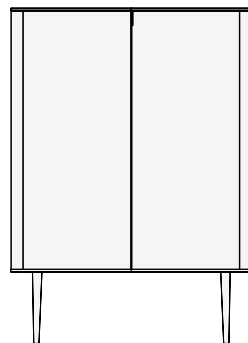

1018
40"

1400
55"

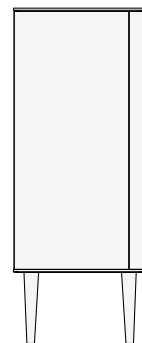

548
21 1/2"

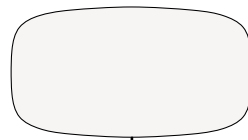
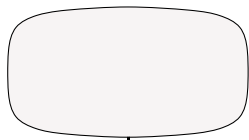

Due ante battenti, un cassetto e un vano a giorno

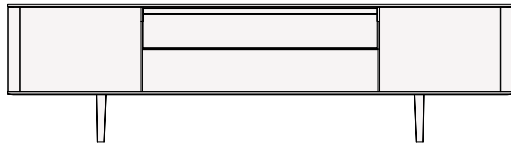

2128
83 3/4"

580
22 3/4"

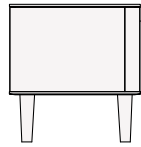

548
21 1/2"

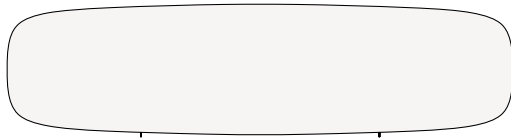

Due ante battenti e due cassetti

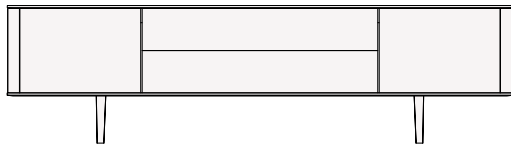

2128
83 3/4"

580
22 3/4"

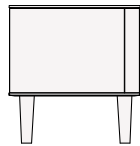

548
21 1/2"

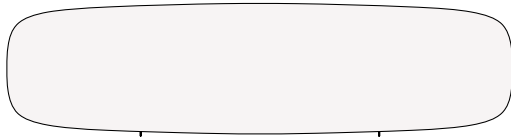

Due ante battenti e tre cassetti

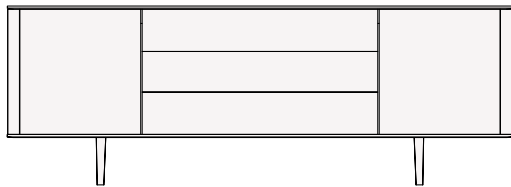

2128
83 3/4"

755
29 3/4"

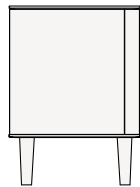

548
21 1/2"

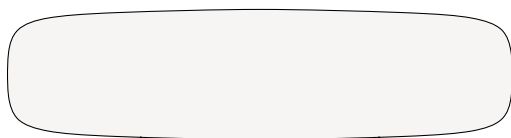

Due ante battenti

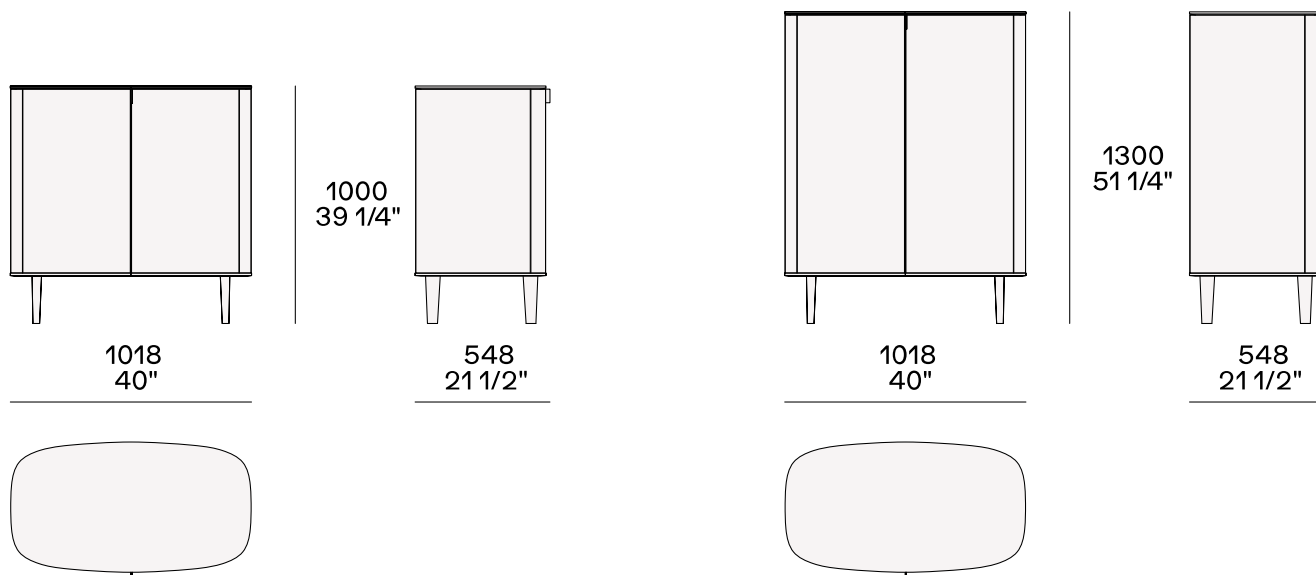

FINITURE STRUTTURA

Essenza

Essenza

FINITURE BASAMENTO

Parti metalliche



Parti metalliche

FINITURE TOP

Essenza

Essenza

Marmo

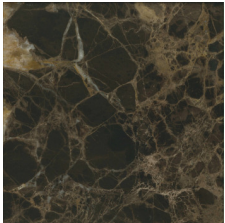

Marmo levigato

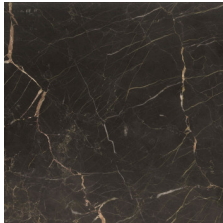

Marmo lucido