



DESCRIPTION

| | |
|--------------------------|---|
| Typology | Sideboard |
| Structure | Panel of wooden particles in veneer |
| Top | Panel of wooden particles in veneer or marble |
| Feet | Aluminium painted |
| Shelf | Glass |
| Drawers structure | Panel of wooden particles melamine |

DIMENSIONS

Two leaf doors, drawer and open compartment

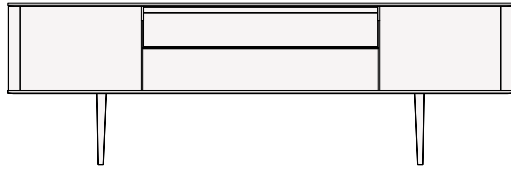

2128
83 3/4"

680
26 3/4"

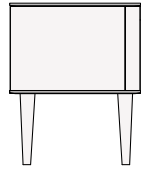

548
21 1/2"

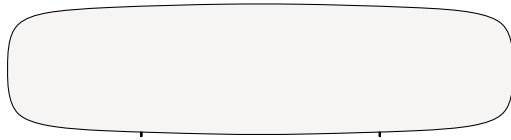

Two leaf doors and two drawers

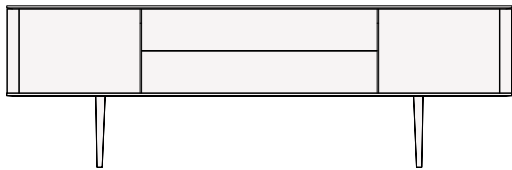

2128
83 3/4"

680
26 3/4"

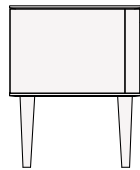

548
21 1/2"

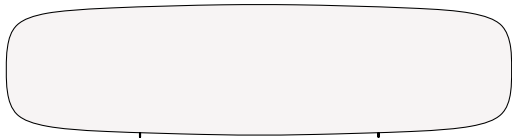

Two leaf doors and three drawers

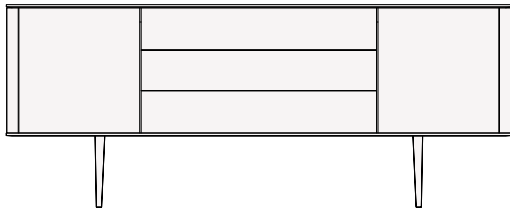

2128
83 3/4"

855
33 3/4"

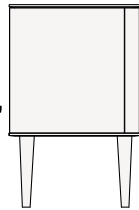

548
21 1/2"

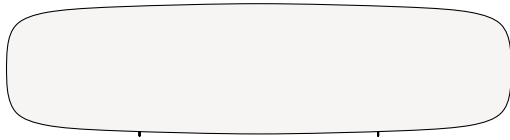

Two leaf doors

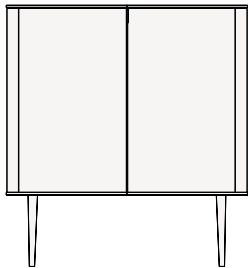

1018
40"

1100
43 1/4"

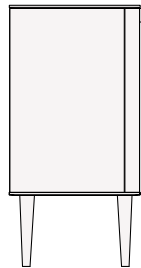

548
21 1/2"

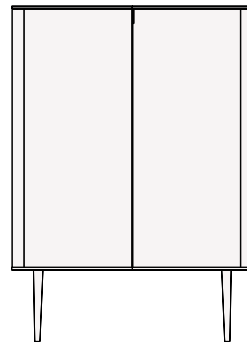

1018
40"

1400
55"

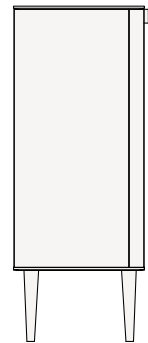

548
21 1/2"

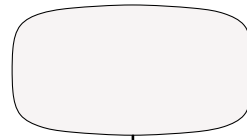
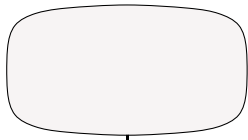

Two leaf doors, drawer and open compartment

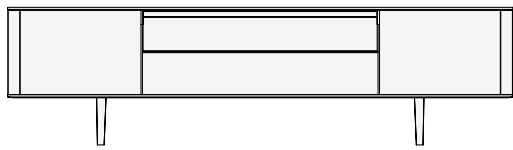

2128
83 3/4"

580
22 3/4"

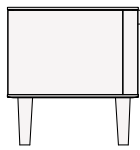

548
21 1/2"

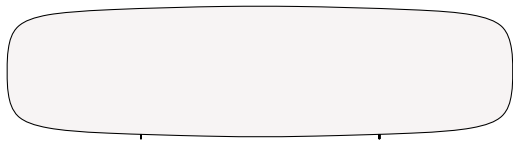

Two leaf doors and two drawers

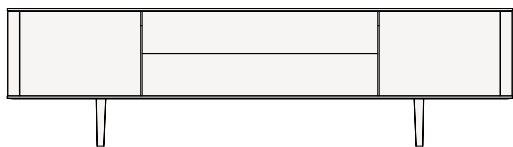

2128
83 3/4"

580
22 3/4"

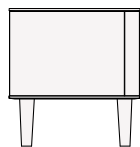

548
21 1/2"

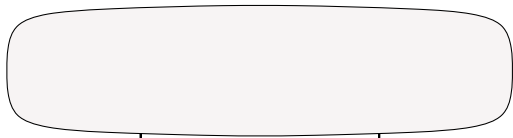

Two leaf doors and three drawers

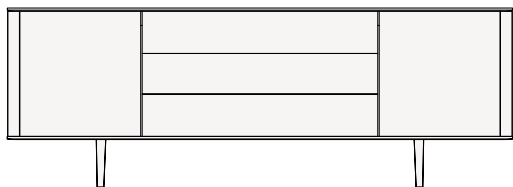

2128
83 3/4"

755
29 3/4"

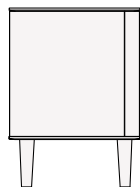

548
21 1/2"

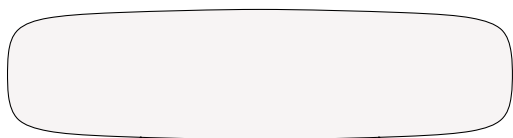

Two leaf doors

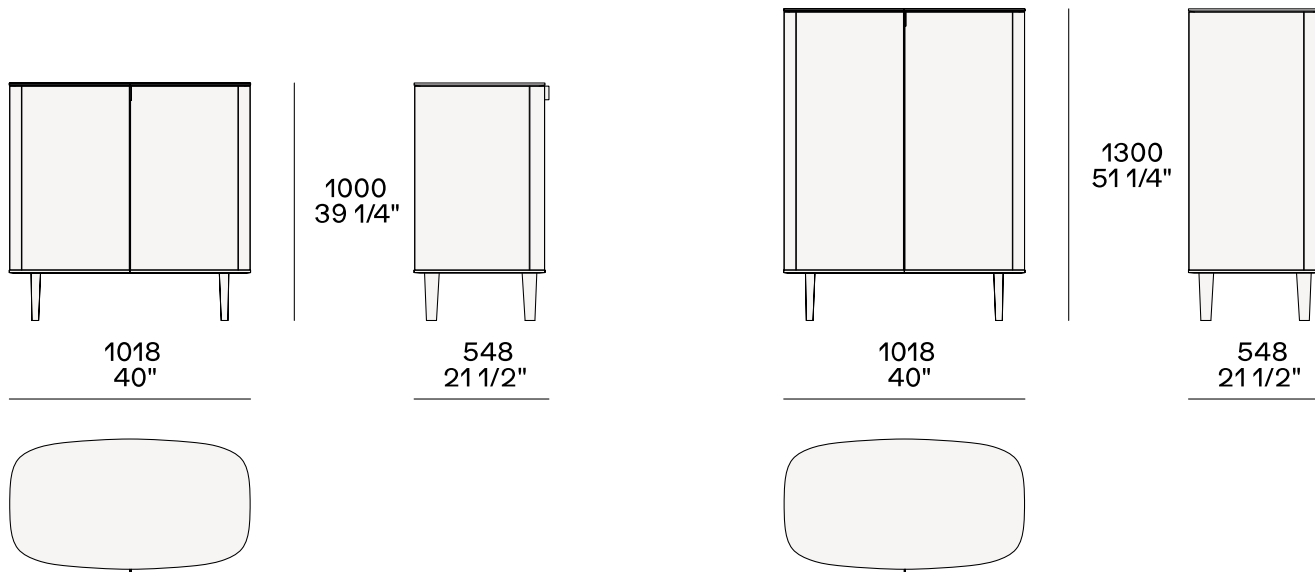

STRUCTURE FINISHES

Wood

Woods

BASE FINISHES

Metal parts



Metal parts

TOP FINISHES

Marble

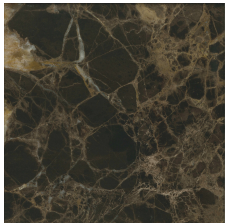

Mat marble

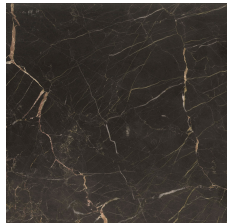

Glossy marble

Wood

Woods