

# STARLIGHT HORIZONTAL

DESIGN MASSIMO CASTAGNA

Certified product:



## STRUCTURE

Dimmable pendant energy saving led lamp (Energy efficiency index A) with Y-shaped central body sandcasting brass, sandcasting bronze or sandcasting Silver. Lighting body in burnished brass, black burnished brass, H-Silver. Low voltage power supply cable through suspension cable. Transformer incorporated in the ceiling rosette. Available alternative fixing system for lamp with remote transformer. Available extra warm light 2700K (without extra costs). Only for indoor use. Dimmable push button. Other dimming systems available upon request. Standard overall height 180 cm.

**HENGE**

## TECHNICAL DATA

### STARLIGHT HORIZONTAL

Cm 134x108x180h with downward pointing led, 3000K

Cm 146x72x180h with downward pointing led, 3000K

Cm 149x94x180h with downward pointing led, 3000K

### STARLIGHT HORIZONTAL MAXI

Cm 226x136x180h with downward pointing led, 3000K

Cm 211x166x180h with downward pointing led, 3000K

Cm 201x100x180h with downward pointing led, 3000K

### STARLIGHT HORIZONTAL XL

Cm 262x147x180h with downward pointing led, 3000K

Cm 311x126x180h with downward pointing led, 3000K

Cm 305x156x108x8h with downward pointing led, 3000K

### STARLIGHT HORIZONTAL XL MAXI

Cm 459x226x180h with downward pointing led, 3000K

Cm 483x280x180h with downward pointing led, 3000K

Cm 405x249x180h with downward pointing led, 3000K

## TECHNICAL DRAWINGS

Starlight Horizontal

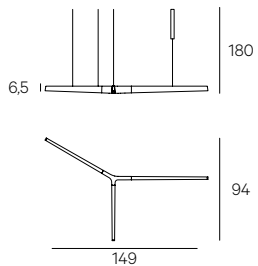
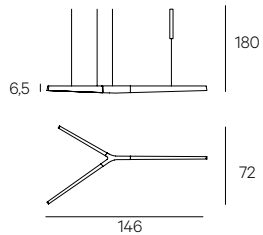
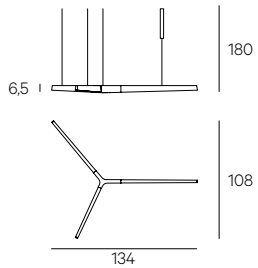

## TECHNICAL DRAWINGS

Starlight Horizontal Maxi

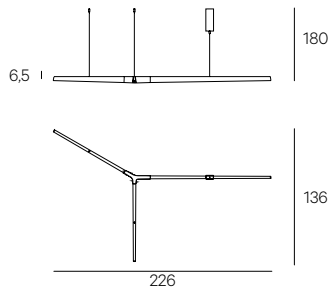
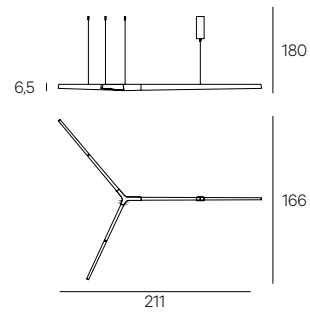
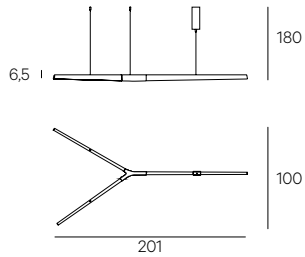

Starlight Horizontal XL

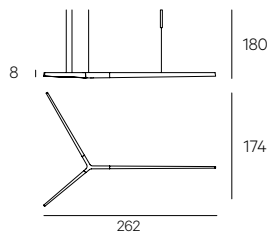
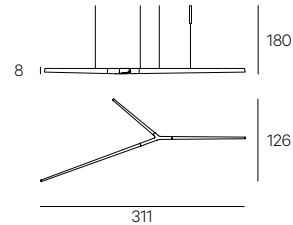
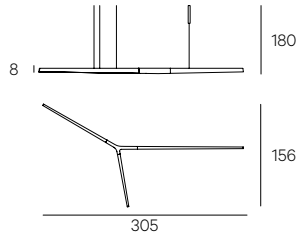

## TECHNICAL DRAWINGS

Starlight Horizontal XL Maxi

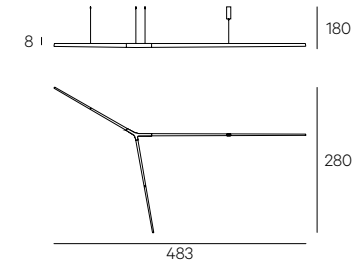
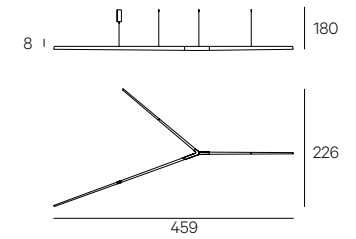
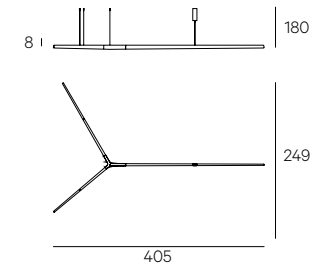

## CARE AND MAINTENANCE OF METALS

Avoid leaving household liquids (oil, red wine, vinegar, etc.) on the surface. In particular, products that contain citric acid (present for example in fruit, citrus fruit and tomatoes) act on contact with the treated surface, removing its original sheen. Always clean stains while they are still fresh. For routine maintenance use a microfiber cloth and water. Do not use products containing acids, limescale removing substances or alcohol.