



Ritual

W 542 Giuseppe Viganò

Structure with metal base and rigid top in poplar plywood.

Perimeter structure in poplar plywood, covered with polyurethane foam bonded with velveteen.

Backrest cushions are in polyurethane foam with an internal shaped metal frame to maintain the shape constantly inclined.

They are fastened to the base with simple bolts.

The foam is medium/soft density with a rounded Memory Foam surface.

All upholstery is in sterilised goose down, covered with a liner with joined resin perimeter strips to maintain the square shape of the cushion.

Seat cushions are in triple layers of medium/firm density polyurethane foam, with a final rounded Memory Foam surface, covered in a sterilised goose down liner with joined resin perimeter strips to maintain the square shape.

The external structure is wrapped in a metal frame, available in the following galvanised finishes: bright shaded brown, bright light gold, matt Champagne gold, bright chrome, bright black chrome, matt satin bronze, bright pink gold, matt pink gold, black Rose gold.

The feet have the same support structure in poplar plywood and are covered in the same upholstery as the sofa, with underbase in laser cut metal painted bronze.

Given the special manufacturing process, the structure upholstery is NOT removable, but the seat cushion upholstery in leather or fabric can be removed.

TECHNICAL DRAWINGS

Divani / Sofas / Диваны

scala 1:50

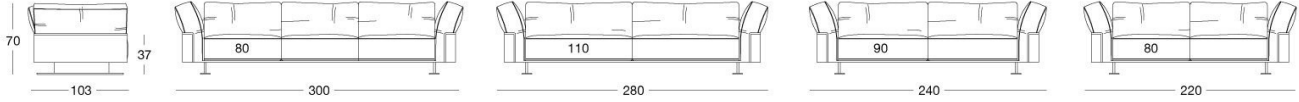

Terminali Sx / End unit L.H. / Боковые секции Л

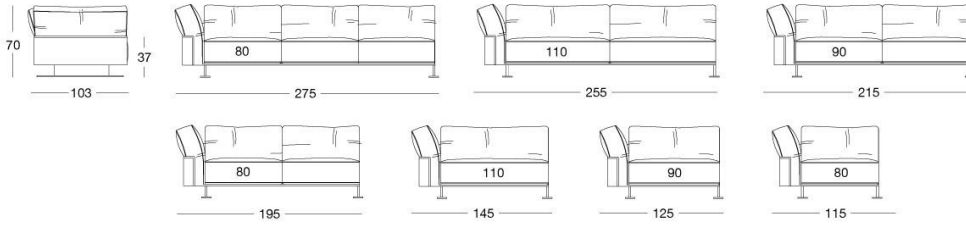

Terminali Dx / End unit R.H. / Боковые секции П

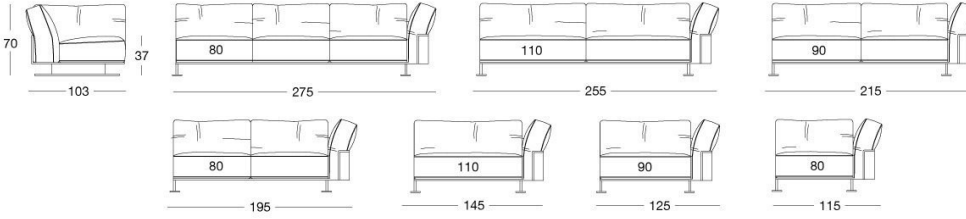

Centrali / Central / Центральные секции

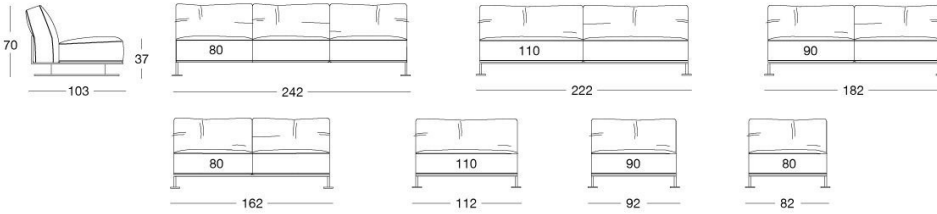

Dormeuse con braccioli / chaise longue with armrests / шезлонг с подлокотниками

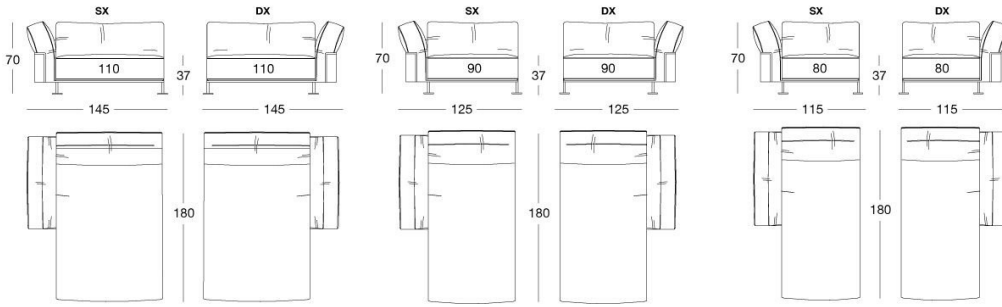

Maxi chaise longue / chaise longue maxi / шезлонг макси

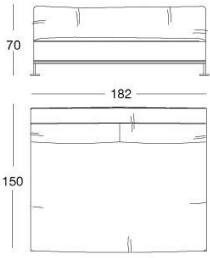

Dormeuse senza braccioli / chaise longue without armrests / шезлонг без подлокотников

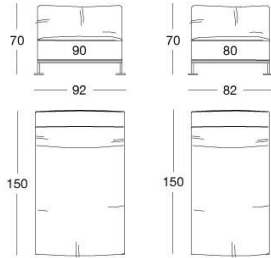

Angolo aperto / Open corner / Открытый угловой элемент

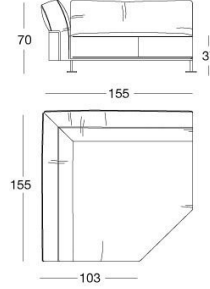

Angolo / Corner / Угловой элемент

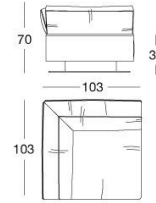

Pouf / Ottoman / Пуф

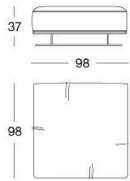

Tavolino con pouf / Small table with pouf / Столик с пуфом

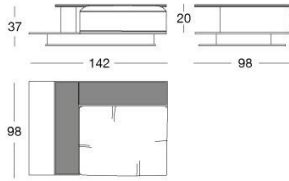

Mensola / shelf / полка

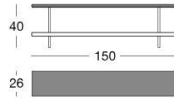

Cuscino / cushion / подушка

