

Classic

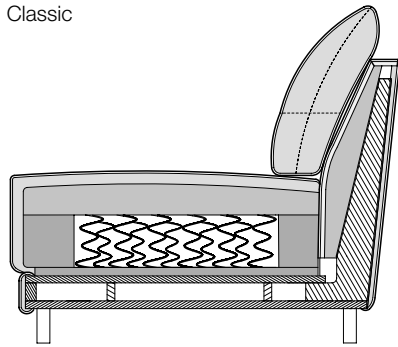

- // Wooden inner frame
- // Coil spring unit
- // Seat in polyurethane foam, built up in varying height and firmness
- // Comfort layer in the seat made from punched flexible foam matting
- // Back pad in polyurethane foam
- // Comfort layer in the back made from nonwoven polyester
- // Downy-soft cushions, worked into ticking chambers with a filling of foam rods and polyester fibres
- // Choice of wood or metal for legs

! Wave formation and depressions in the seat area are unavoidable, due to comfort and design reasons, even in high quality Rolf Benz upholstered furniture. All measurements are approximate.

Lounge

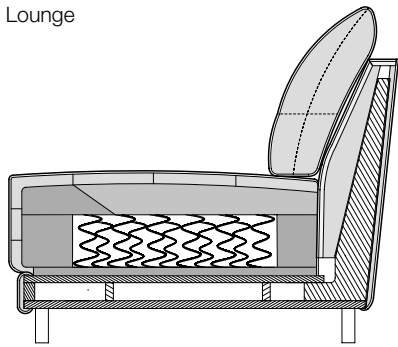

- // Wooden inner frame
- // Coil spring unit
- // Seat in polyurethane foam, built up in varying height and firmness
- // Comfort layer in the seat made from a mat worked into ticking chambers and filled with rods and fibres
- // Back pad in polyurethane foam
- // Comfort layer in the back made from nonwoven polyester
- // Downy-soft cushions, worked into ticking chambers with a filling of foam rods and polyester fibres
- // Choice of wood or metal for legs

! Wave formation and depressions in the seat area are unavoidable, due to comfort and design reasons, even in high quality Rolf Benz upholstered furniture. All measurements are approximate.

Armchair

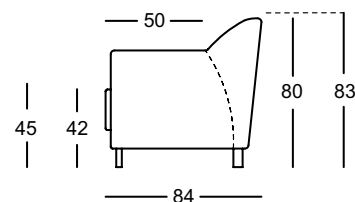

Sofa etc.

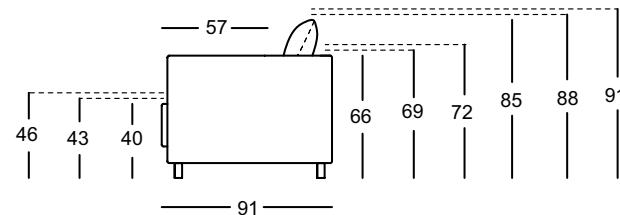

Armchair

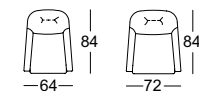

Sofa

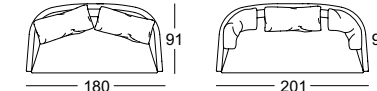

Closing chair with armrest



Extra deep closing chair

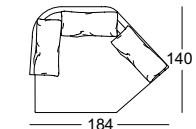

Sectional sofa



Corner modular sofa element

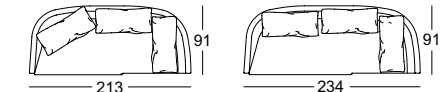

Closing chair with fixed footstool

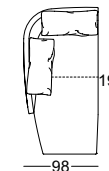

Sectional sofa with fixed footstool, round

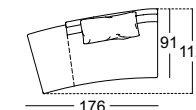

Sectional sofa with fixed footstool

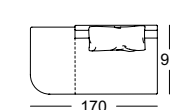

Sectional sofa, round

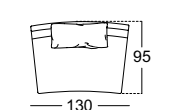

Sectional sofa

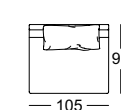

Sectional armchair

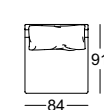

Corner unit with round back

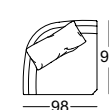

Corner sofa

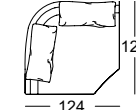

Upholstered bench element

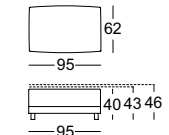

Footstool

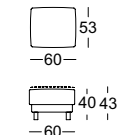

Flanged back cushion

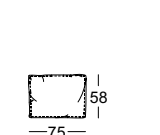

Flanged back cushion mat

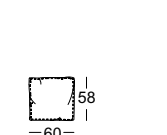

Flanged cushion

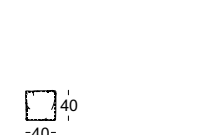

### ROLF BENZ 8100 - COFFEE TABLE



- // Oval coffee table, on castors, available in several versions
- // Table top: 12 mm clear glass (ESG) swivellable and height adjustable
- // Pedestal: MDF painted matt or gloss according to RAL 9010 white, RAL 3011 brown red, RAL 8019 grey brown, RAL 7021 black grey, RAL 9017 black
- // Pillar: matt chrome or polished chrome
- // Dimensions: 100 x 70 x 42 cm

### ROLF BENZ 8200 - COFFEE TABLE



- // Oval side table on gliders, in several versions
- // Table top: 10 mm clear glass (ESG), fixed or adjustable height
- // Pedestal: MDF painted matt or gloss according to RAL 9010 white, RAL 3011 brown red, RAL 8019 grey brown, RAL 7021 black grey, RAL 9017 black
- // Pillar: matt or polished chrome
- // Dimensions: 58 x 42 x 45 cm

All technical specifications relevant to the furniture ranges are correct at the time of publication. Subsequent modifications are possible. All dimensions are approximate. For technical reasons, printed pictures of fabric and leather upholstery covers may deviate from the original. Only the original samples provided are binding for the final appearance of the fabric.

