

NASH



design
Mauro Lipparini 2017

STRUCTURE: metal

STRUCTURE UPHOLSTERY: structure and back in expanded polyurethane of varied densities (HR30-28 + NF21-20), covered with synthetic lining 380gr. Seat in expanded polyurethane of varied densities (HR36-36 + limpha 40M + SOFF35s), covered with synthetic lining 380gr

SPRINGING: elastic belts

ARM: cold-expanded polyurethane. Attention: available only in leather

SEAT HEIGHT: 40 cm

ARM HEIGHT: 56 cm (fix); 50/55 cm (with arm in leather 6109760 + 6109761)

FEET: metal, finishes: titanium or black nickel or varnished micaceous brown or oxy grey, h.12,5 cm

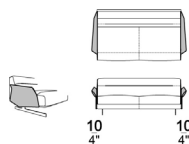

note 1

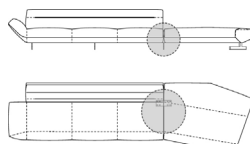

note 2

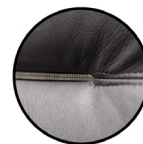

note 3

1. If the thin leather arm is added to the unit, the length of the unit will be increased by 10 cm. **ATTENTION:** the arm in leather is not included in the price of units and compositions
2. By some compositions the standard feet where the two units are joined are replaced by central feet.
3. It is possible to replace the seam of the back with a decorative metal zip with an extra charge

NASH

Sofa

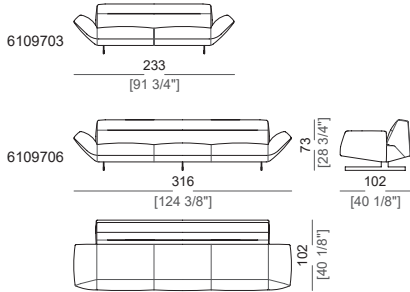

Right or left unit

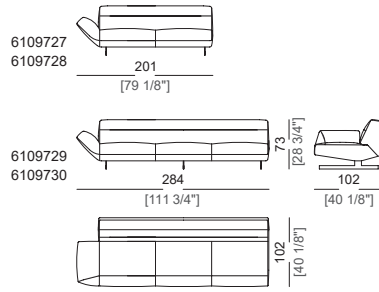

Central unit

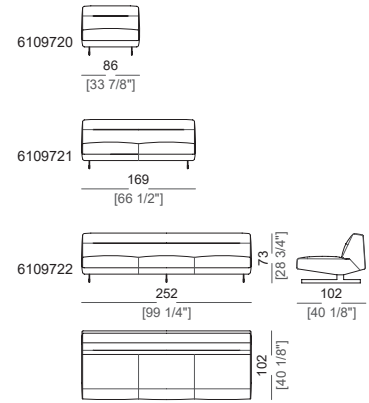

Right or left arm

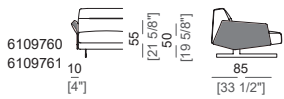

il bracciolo raffigurato è sx

Right corner

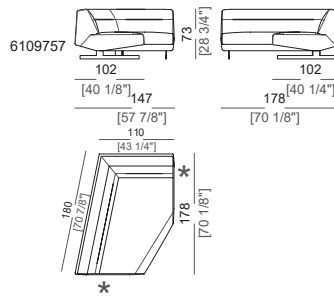

Left corner

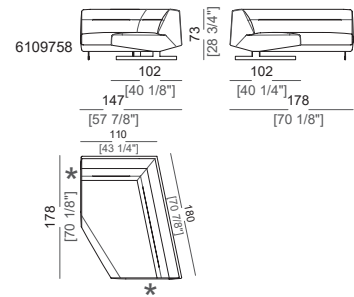

Right unit

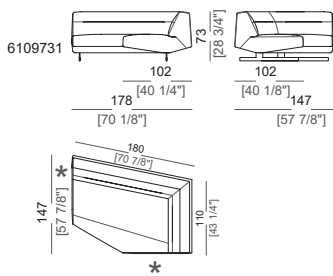

Left unit

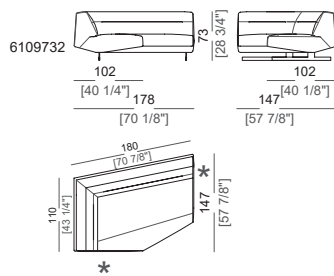

NASH

Right or left dormeuse

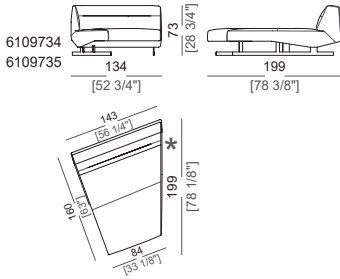

l'elemento raffigurato è sx

Right or left dormeuse

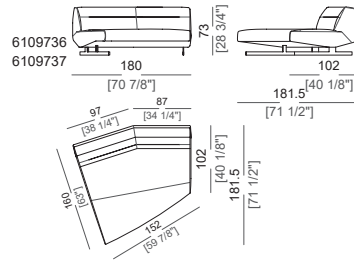

l'elemento raffigurato è sx

Pouf

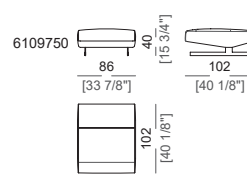

Right or left pouf

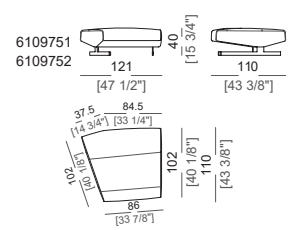

l'elemento raffigurato è dx

Composition A

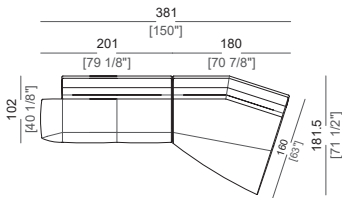

Composition B

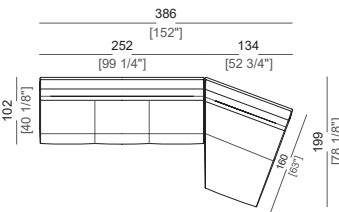

Composition C

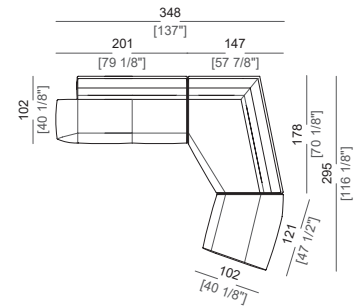

Composition D

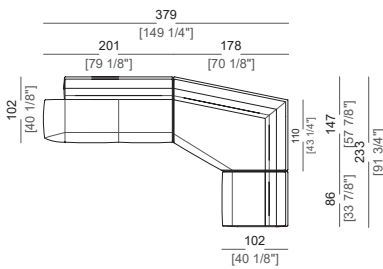

Composition G

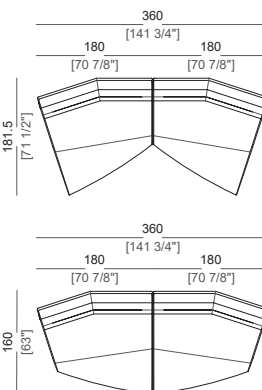

Composition I

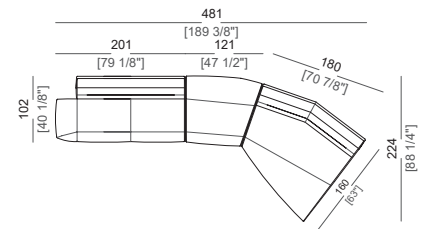

NASH

Composition L

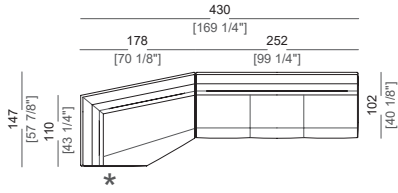

Composition M

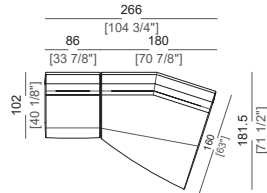

Composition N

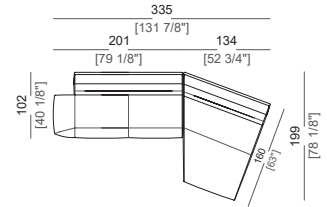

Composition O

