

TECHNICAL DATA

ROLF BENZ 318 LINEA



**ROLF
BENZ**

- Wooden inner frame
- Nosag spring support
- Cover quilted underneath with non-woven polyester
- Back in polyurethane foam
- Classic:
 - Seat in polyurethane foam, built up in coordinated layers varying in height and firmness
- Lounge plus:
 - Seat of top-grade cold foam
- Base options:
 - Brace stainless steel
 - Spang gelakt in verkeerszwart RAL 9017
- Conical base options:
 - Base oak H70
 - Base oak H98
 - Base walnut H81

▮ Wave formation and depressions in the seat area are unavoidable, due to comfort and design reasons, even in high quality Rolf Benz upholstered furniture. All measurements are approximate.

Classic

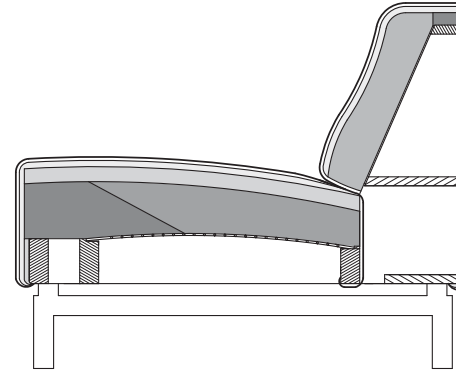

Lounge plus

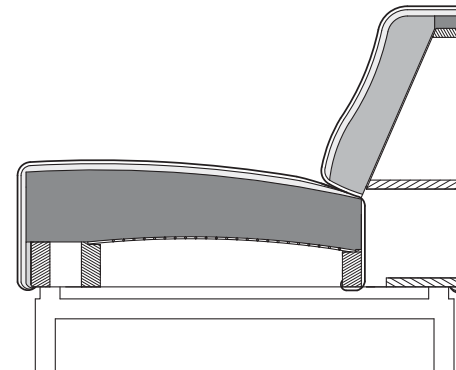

Seat heights available



**ROLF
BENZ**

Armchair

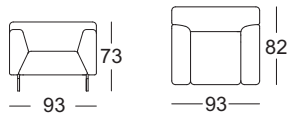

Sofa

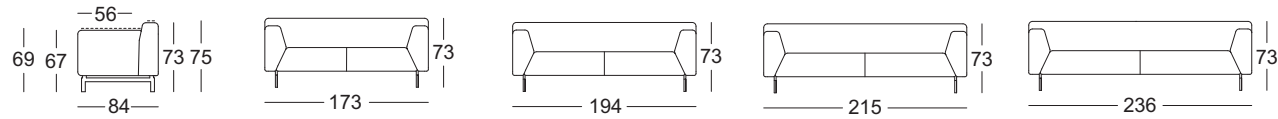

Sectional sofa*

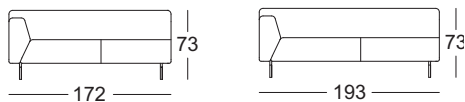

Closing chair with fixed footstool*

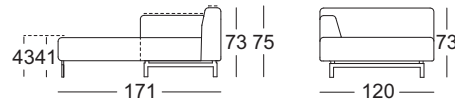

Corner sectional sofa with fixed footstool*

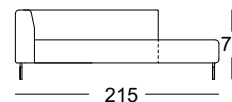

Extra deep armchair

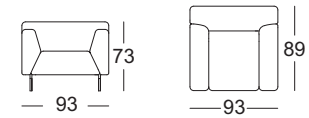

Extra deep sofa

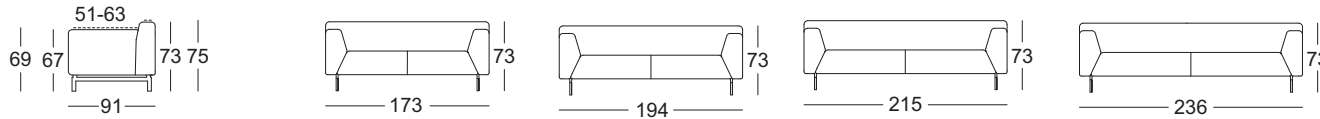

Extra deep sectional sofa*

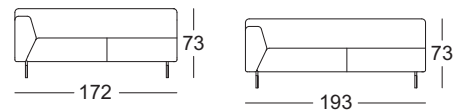

Extra deep closing chair with fixed footstool*

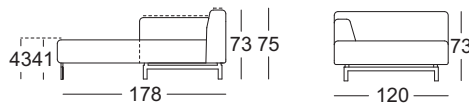

Extra deep corner sectional sofa with fixed footstool*

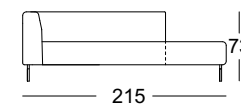

Upholstered bench element

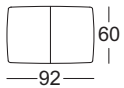

Footstool

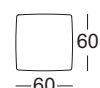

Low back cushions

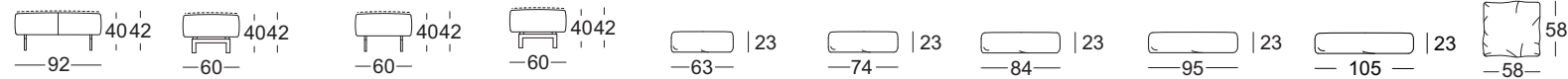

Back cushion

**ROLF
BENZ**

Combination examples

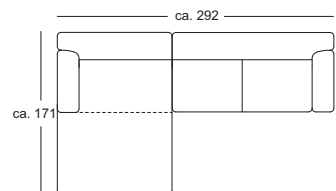

ASS-PSZ 318/120 le.
ASO 318/172 ri.

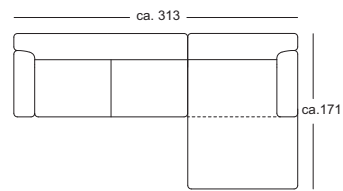

Ü-ASO 318/193 le.
Ü-ASS-PSZ 318/120 ri.

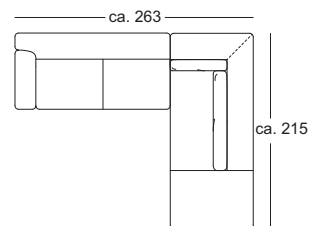

ASO 318/172 le.
Ü-E-ARB_PSZ 318/215 ri.

*These elements are only shown in the left version. They are also available in the right version.

**ROLF
BENZ**