



Caratteristiche: Sistema di sedute dalla linea solida ed essenziale; alto da terra, è caratterizzato da un piede a ponte in fusione di alluminio che gli conferisce leggerezza e dinamismo. Un bordino nello stesso tessuto del rivestimento scelto aggiunge un tocco di eleganza al modello. Un elemento distintivo importante è dato dalla possibilità di scegliere tra due diverse misure di bracciolo, uno di spessore cm. 25 e uno di spessore cm. 15. Le diverse dimensioni dei braccioli permettono di realizzare differenti configurazioni estetiche e, con il bracciolo da cm. 15, a parità di larghezza di seduta, ottenere un minore ingombro esterno. Divani, laterali, laterali angoli, dormeuse e chaise longue sono disponibili sia con i braccioli da cm. 25 che con i braccioli da cm.15. I rimanenti moduli in collezione quali elementi, angoli, terminali e dormeuse angolo si possono accostare ad entrambe le tipologie di bracciolo. Pouf in diverse misure completano il sistema. Irving offre inoltre la possibilità di scegliere fra due differenti versioni di schienale: con schienali rettangolari (tipo "A") o con cuscini-schienale (tipo "B" cm. 57x53) in quantità predefinita. Per permettere una maggiore personalizzazione Irving si può realizzare anche nella versione "BASE" (senza cuscini-schienale) da completare con i cuscini-schienale scelti fra quelli proposti in collezione. Nella versione con il bracciolo da cm. 25 è disponibile un comodo piano d'appoggio in cuoio color naturale o testa di moro. Irving si può inoltre attrezzare con i tavolini della serie Club. Il rivestimento è completamente sfoderabile ad eccezione della versione in pelle. **Struttura:** Fusto in legno massello e multistrato, imbottito in poliuretano espanso indeformabile a densità differenziata, molleggio con nastri elastici intrecciati. Prerivestimento con tela di cotone accoppiata con fibra poliestere. Piede a ponte di serie in fusione di alluminio verniciato color bronzo oppure, su richiesta, in fusione di alluminio lucidato. **Imbottiture cuscini:** Cuscini di seduta in poliuretano espanso indeformabile a densità differenziata e fibra poliestere. Cuscini-schienale tipo "A" in piuma canalizzata con inserto in poliuretano; cuscini-schienale tipo B (cm. 57x53) sono interamente in piuma canalizzata. Cuscini decorativi e poggiatesta opzionali sono completamente in piuma. Tutte le imbottiture sono interamente prerivestite con tela bianca.

Features: Seating system distinguished by a solid and essential line; high from the ground, characterized by a bridge-shaped foot in aluminium cast that confers lightness and dynamism. A piping in the same fabric chosen for the cover gives a touch of elegance to the model. An important hallmark for this collection is the possibility to choose between two different sizes of armrest, one it's 25 cm, thick and one it's 15 cm, thick. The two alternatives in the armrest width allow different options of esthetic configurations. Thanks to the 15 cm. thick armrest it is possible to create sectionals, with the same seat width, but in a reduced overall space. Sofas, side pieces, side corners, dormeuse and chaise longue are available with both armrests: 25 cm. as well as with 15 cm. The remaining modules of the collection such as elements, corners, end pieces and corner dormeuse can be combined with both kinds of armrest. Pouf in different sizes complete the system. Irving offers the possibility to choose between two backrest versions: with rectangular backrests (type "A") or with backrest-cushions (type "B" 57x53 cm) in a predefined quantity. Irving is also available in the "BASE" version (without backrest cushions) to be equipped and completed with backrest cushions selected among those available in the collection. For the 25 cm armrest a comfortable plate in leather in natural color or dark brown shade is available. Irving can be also equipped with the series Club table. The cover can be completely and easily removed with the exception of the leather cover. **Framework:** Frame made of solid and plywood, padded with non-deformable expanded polyurethane of differentiated density, and sprung with interwoven elastic belts. Cotton lining coupled with polyester fibre. Bridge-shaped feet in bronzed painted aluminium cast as standard, or in polished aluminium cast upon request. **Cushion padding:** Seat cushions in non-deformable expanded polyurethane with differentiated densities, and polyester fibre. Backrest-cushions type "A" with canalised feather and polyurethane insert; backrest-cushions type "B" entirely made with canalised feather. Optional cushions and lumbar-cushions are entirely in feather. All padding is fully lined with white fabric.

Eigenschaften: Das Modulsystem mit einer kompakten und essentiellen Linie, nicht bodennah, kennzeichnet ein brückenförmiger Fuß in Aluminiumguss, der ihm Leichtigkeit und Dynamismus verleiht. Ein Keder des gleichen Stoffes, wie für das Sofa gewählt, ergänzt die Eleganz des Modells. Ein wichtiges Unterscheidungsmerkmal liegt in der Möglichkeit, zwischen zwei verschiedenen Armlehnbreiten, entweder 25 cm oder 15 cm, zu wählen. Die unterschiedlichen Armlehnbreiten erlauben verschiedene ästhetische Kompositionen und mit einer 15 cm breiten Armlehne einen geringeren Raumbedarf ohne Sitzflächeneinbuße. Sofas, Seitenteile, Seiteneckelemente, Dormeuse und Chaiselongue sind sowohl mit den 25 cm breiten als auch mit den 15 cm breiten Armlehnen erhältlich. Die restlichen Module wie Zentralelemente, Eckelemente, Endelemente und Eckdormeuse können an beide Armlehtypen gestellt werden. Hocker in verschiedenen Größen vervollständigen das System. Irving bietet auch die Möglichkeit zwischen zwei unterschiedlichen Rückenkissen zu wählen: traditionelle rechteckige Rückenkissen (Typ „A“) oder informelle Rückenkissen (Typ „B“ 57x53 cm) in vorbestimmter Anzahl. Eine individuelle Gestaltung des Modells Irving lässt sich mit der Version „Basis“ (d.h. ohne Rückenkissen) realisieren, die mit den in der Kollektion verfügbaren Rückenkissen frei vervollständigigt werden kann. Für die 25 cm breite Armlehne gibt es eine komfortable Armlehnenablage in hellbraunem oder dunkelbraunem Leder. Irving kann auch mit den Beistelltischen der Serie Club ergänzt werden. Die Bezüge sind komplett abnehmbar, mit Ausnahme der Lederausführung. **Struktur:** Der Korpus besteht aus Massiv- und Mehrschichtholz, gepolstert mit formstabilem Polyurethan unterschiedlicher Dichte und einer Federung mit geflochtenen elastischen Bändern. Unterbezug aus weißem Baumwollstoff mit Polyesterfaser. Brückenförmiger Fuß in bronzefarbenem Aluminiumguss serienmäßig oder, auf Anfrage, poliert. **Polster:** Sitzkissen aus formstabilem Polyurethan unterschiedlicher Dichte und Polyesterfaser. Die Rückenkissenpolsterung Typ „A“ besteht aus in Kammern gesteppten Federn und einem formstabilen Polyurethankern. Rückenkissen Typ „B“ (57x53 cm) sind gänzlich aus in Kammern gesteppten Federn. Wurfkissen und Lendenkissen haben eine komplette Federfüllung. Alle Polster sind mit einem weißen Schonbezug verkleidet.

PIEDE FOOT FUSS

Fusione di alluminio verniciato color bronzo (di serie);
fusione di alluminio lucidato (su richiesta).
Bronze painted aluminium cast (series);
polished cast aluminium (upon request).
Standardausführung in bronzefarbenem Aluminiumguss;
Auf Anfrage in Aluminiumguss poliert.

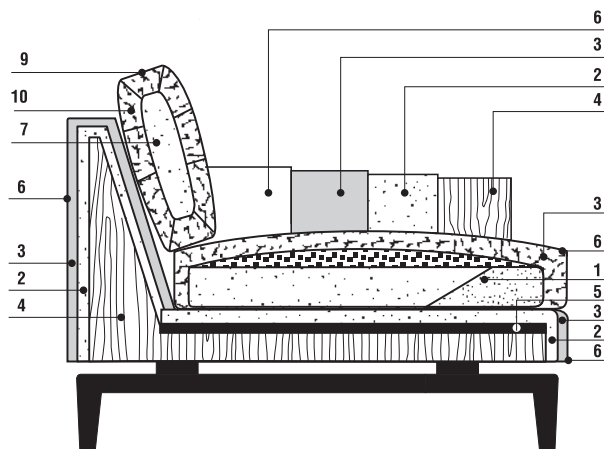
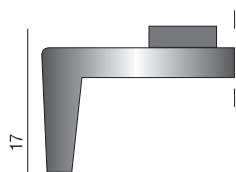

SEZIONE SECTION SEKTION

- 1: Poliuretano a densità differenziata.
Differentiated density polyurethane.
Polyurethan unterschiedlicher Dichte.
- 2: Poliuretano. Polyurethane. Polyurethan.
- 3: Fibra Poliestere. Polyester Fibre.
Polyesterfaser.
- 4: Fusto in legno massello e multistrato.
Frame in solid wood and plywood.
Korpus aus Massivholz, und schichtverleimt.
- 5: Nastri elastici. Elastic belts. Elastische Gurte.
- 6: Fodera in tela. Fabric lining. Schonbezug.
- 7: Inserto in Poliuretano. Polyurethane insert.
Kern aus Polyurethan.
- 8: Fibra Poliestere cardata, canalizzata.
Teased and canalised polyester fibre.
Gekämmte, in Kammern gesteppte Polyesterfaser.
- 9: Fodera in tessuto antipiuma.
Featherproof fabric cover.
Daunenunterchlässiger Bezug des Kisseninlets.
- 10: Piuma. Down. Daunenfüllung.

IRVING VERSIONE A

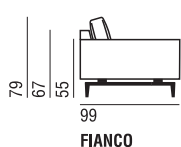

FIANCO

IRVING VERSIONE B

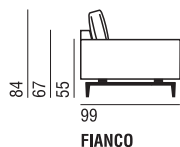

FIANCO

IRVING VERSIONE BASE

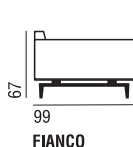

FIANCO

BRACCIOLO 25 CM

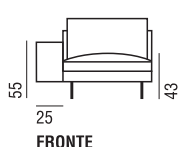

FRONTE

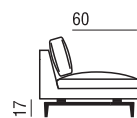

SEZ. DEL FIANCO

BRACCIOLO 15 CM

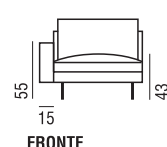

FRONTE

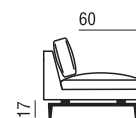

SEZ. DEL FIANCO

IRVING MODULI CON BRACCIOLI 25 CM. VERSIONE A

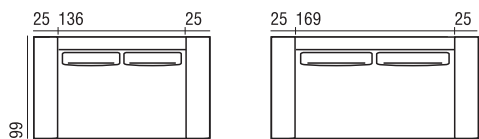

186

DIVANO 186 - 25 A
cuscino unico

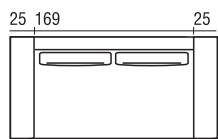

219

DIVANO 219 - 25 A
cuscino unico

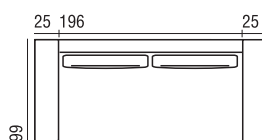

246

DIVANO 246 - 25 A
cuscino unico

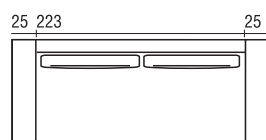

273

DIVANO 273 - 25 A
cuscino unico

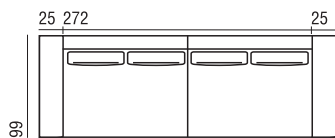

322

DIVANO 322 - 25 A
composto da 2 laterali 161 SX e DX cuscini unici

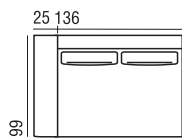

161

LATERALE 161 - 25 A SX
cuscino unico

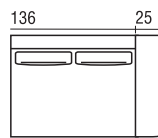

161

LATERALE 161 - 25 A DX
cuscino unico

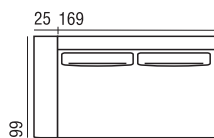

194

LATERALE 194 - 25 A SX
cuscino unico

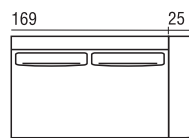

194

LATERALE 194 - 25 A DX
cuscino unico

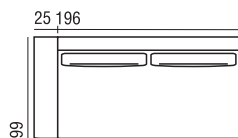

221

LATERALE 221 - 25 A SX
cuscino unico

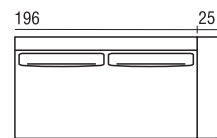

221

LATERALE 221 - 25 A DX
cuscino unico

IRVING MODULI CON BRACCIOLI 25 CM. VERSIONE B

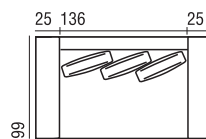

186

DIVANO 186 - 25 B
cuscino unico

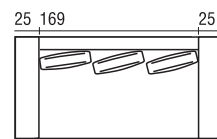

219

DIVANO 219 - 25 B
cuscino unico

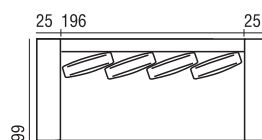

246

DIVANO 246 - 25 B
cuscino unico

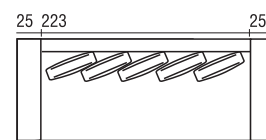

273

DIVANO 273 - 25 B
cuscino unico

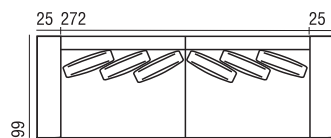

322

DIVANO 322 - 25 B
composto da 2 laterali 161 SX e DX cuscini unici

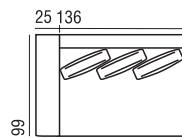

161

LATERALE 161 - 25 B SX
cuscino unico

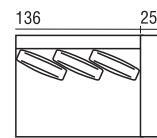

161

LATERALE 161 - 25 B DX
cuscino unico

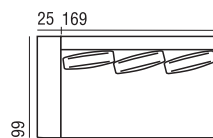

194

LATERALE 194 - 25 B SX
cuscino unico

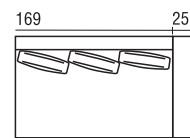

194

LATERALE 194 - 25 B DX
cuscino unico

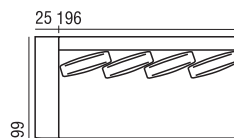

221

LATERALE 221 - 25 B SX
cuscino unico

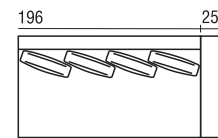

221

LATERALE 221 - 25 B DX
cuscino unico

IRVING MODULI CON BRACCIOLI 25 CM. VERSIONE A

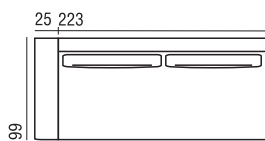

LATERALE 248 - 25 A SX
cuscino unico

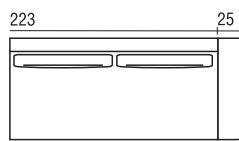

LATERALE 248 - 25 A DX
cuscino unico

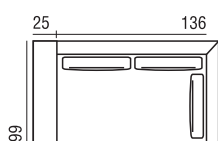

ANGOLO LATERALE 181 - 25 A SX
cuscino unico

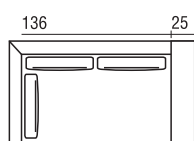

ANGOLO LATERALE 181 - 25 A DX
cuscino unico

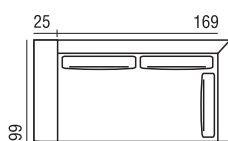

ANGOLO LATERALE 214 - 25 A SX
cuscino unico

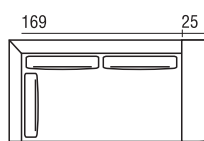

ANGOLO LATERALE 214 - 25 A DX
cuscino unico

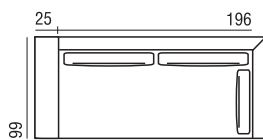

ANGOLO LATERALE 241 - 25 A SX
cuscino unico

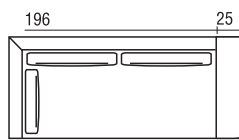

ANGOLO LATERALE 241 - 25 A DX
cuscino unico

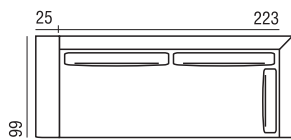

ANGOLO LATERALE 268 - 25 A SX
cuscino unico

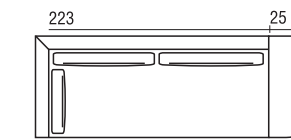

ANGOLO LATERALE 268 - 25 A DX
cuscino unico

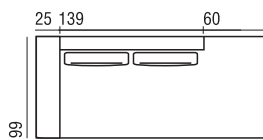

DORMEUSE 224 - 25 A SX
cuscino unico

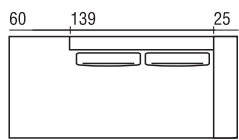

DORMEUSE 224 - 25 A DX
cuscino unico

IRVING MODULI CON BRACCIOLI 25 CM. VERSIONE B

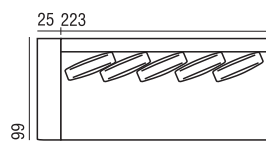

LATERALE 248 - 25 B SX
cuscino unico

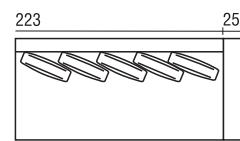

LATERALE 248 - 25 B DX
cuscino unico

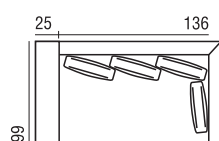

ANGOLO LATERALE 181 - 25 B SX
cuscino unico

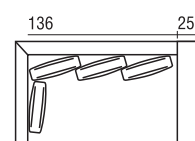

ANGOLO LATERALE 181 - 25 B DX
cuscino unico

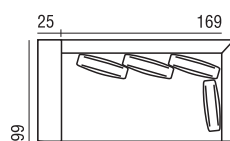

ANGOLO LATERALE 214 - 25 B SX
cuscino unico

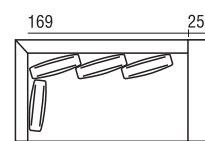

ANGOLO LATERALE 214 - 25 B DX
cuscino unico

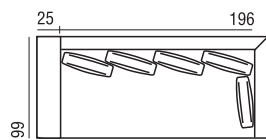

ANGOLO LATERALE 241 - 25 B SX
cuscino unico

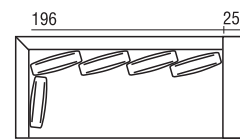

ANGOLO LATERALE 241 - 25 B DX
cuscino unico

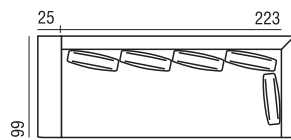

ANGOLO LATERALE 268 - 25 B SX
cuscino unico

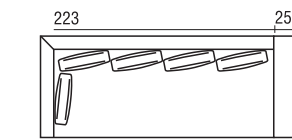

ANGOLO LATERALE 268 - 25 B DX
cuscino unico

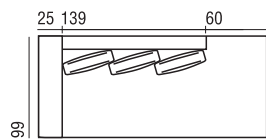

DORMEUSE 224 - 25 B SX
cuscino unico

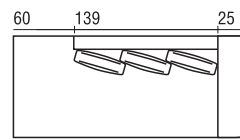

DORMEUSE 224 - 25 B DX
cuscino unico

IRVING MODULI CON BRACCIOLI 25 CM. VERSIONE A

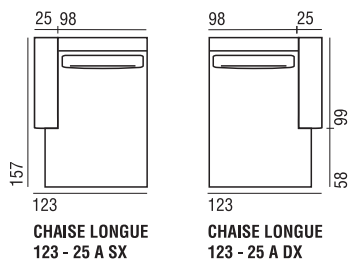

IRVING MODULI CON BRACCIOLI 25 CM. VERSIONE B

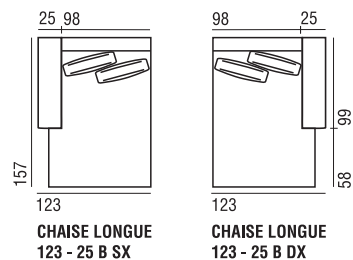

IRVING MODULI CON BRACCIOLI 15 CM. VERSIONE A

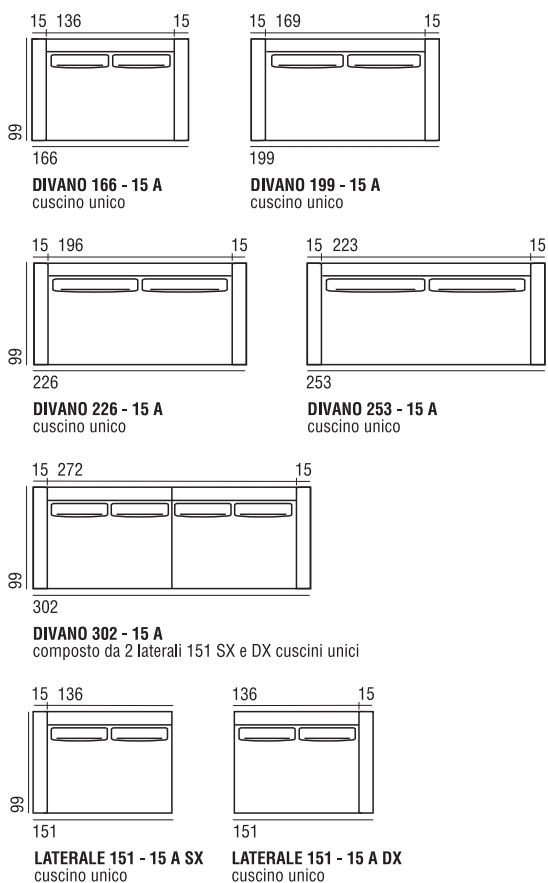

IRVING MODULI CON BRACCIOLI 15 CM. VERSIONE B

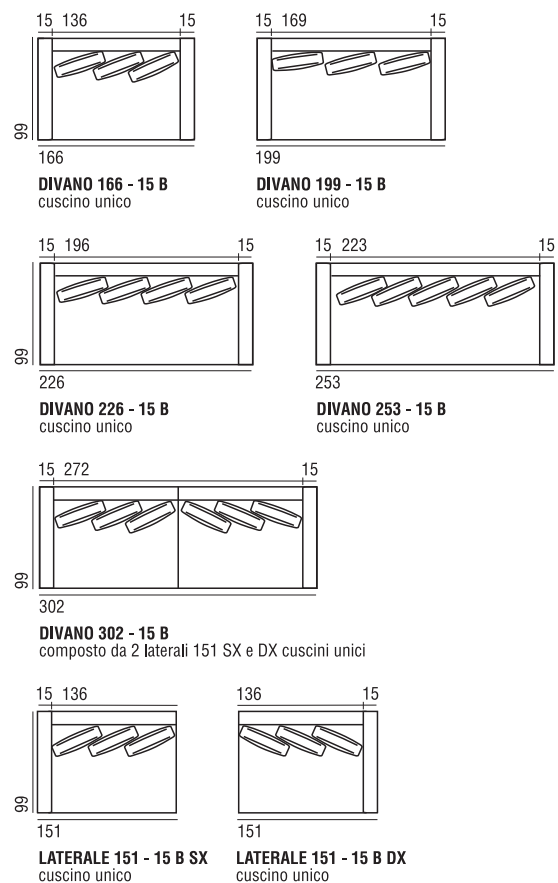

IRVING MODULI CON BRACCIOLI 15 CM. VERSIONE A

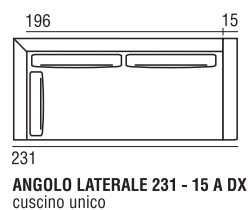
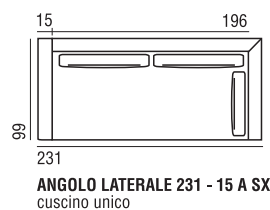
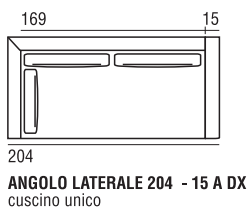
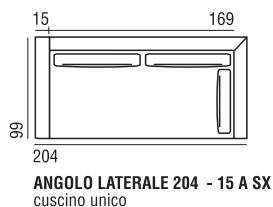
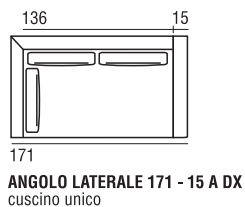
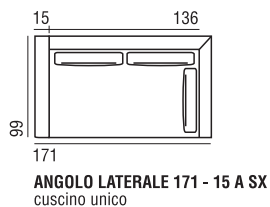
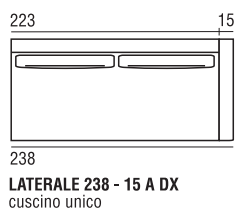
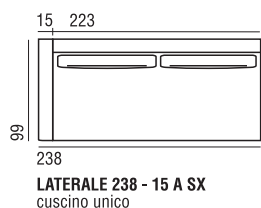
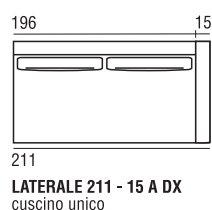
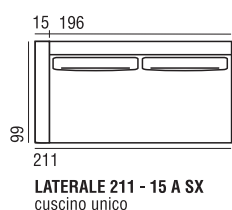
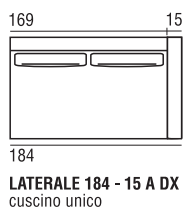
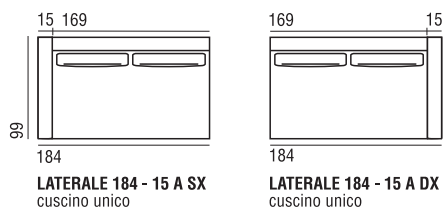

IRVING MODULI CON BRACCIOLI 15 CM. VERSIONE B

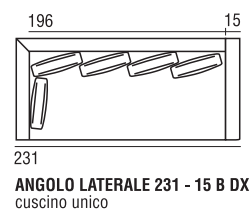
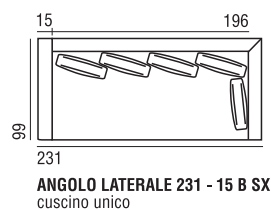
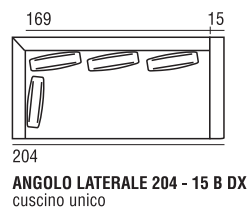
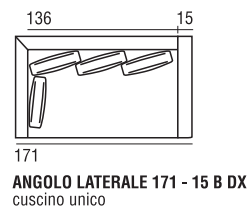
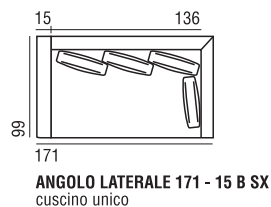
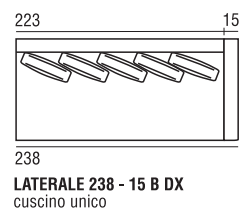
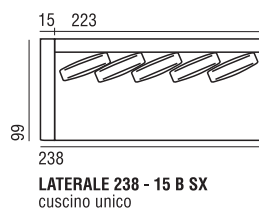
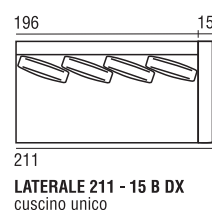
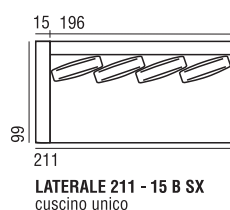
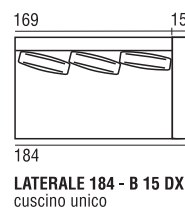
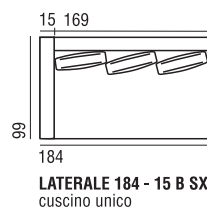

IRVING MODULI CON BRACCIOLI 15 CM. VERSIONE A

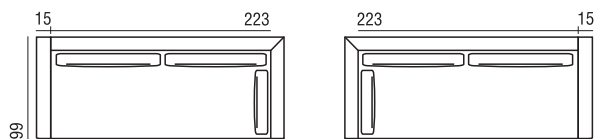

258
ANGOLO LATERALE 258 - 15 A SX
cuscino unico

258
ANGOLO LATERALE 258 - 15 A DX
cuscino unico

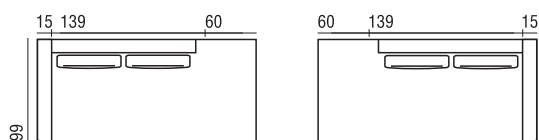

214
DORMEUSE 214 - 15 A SX
cuscino unico

214
DORMEUSE 214 - 15 A DX
cuscino unico

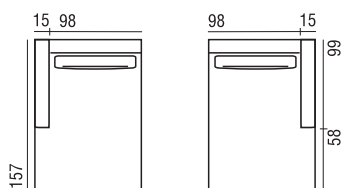

113
CHAISE LONGUE
113 - 15 A SX

113
CHAISE LONGUE
113 - 15 A DX

IRVING MODULI CON BRACCIOLI 15 CM. VERSIONE B

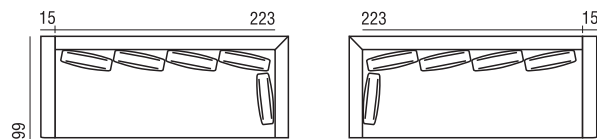

258
ANGOLO LATERALE 258 - 15 B SX
cuscino unico

258
ANGOLO LATERALE 258 - 15 B DX
cuscino unico

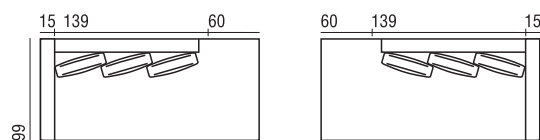

214
DORMEUSE 214 - 15 B SX
cuscino unico

214
DORMEUSE 214 - 15 B DX
cuscino unico

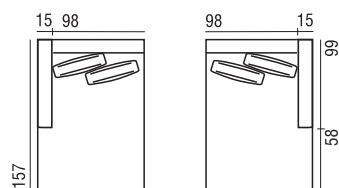

113
CHAISE LONGUE
113 - 15 B SX

113
CHAISE LONGUE
113 - 15 B DX

IRVING MODULI SENZA BRACCIOLI VERSIONE A

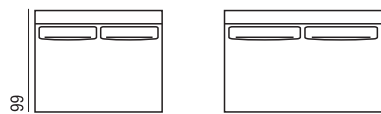

136
ELEMENTO 136 A
cuscino unico

169
ELEMENTO 169 A
cuscino unico

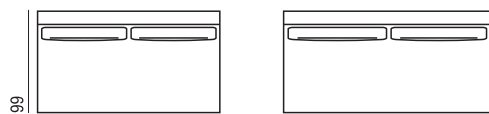

196
ELEMENTO 196 A
cuscino unico

223
ELEMENTO 223 A
cuscino unico

IRVING MODULI SENZA BRACCIOLI VERSIONE B

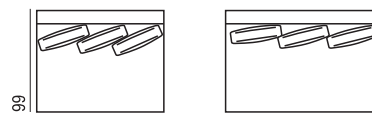

136
ELEMENTO 136 B
cuscino unico

169
ELEMENTO 169 B
cuscino unico

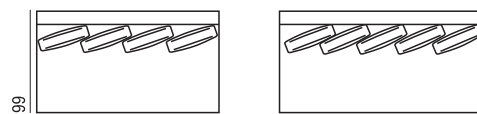

196
ELEMENTO 196 B
cuscino unico

223
ELEMENTO 223 B
cuscino unico

IRVING MODULI SENZA BRACCIOLI VERSIONE A

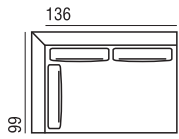

ANGOLO 156 A SX
cuscino unico

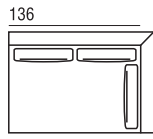

ANGOLO 156 A DX
cuscino unico

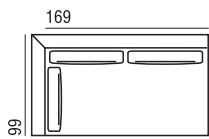

ANGOLO 189 A SX
cuscino unico

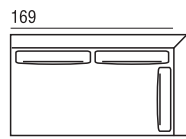

ANGOLO 189 A DX
cuscino unico

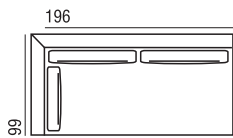

ANGOLO 216 A SX
cuscino unico

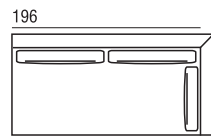

ANGOLO 216 A DX
cuscino unico

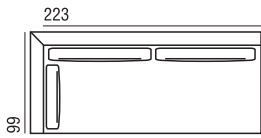

ANGOLO 243 A SX
cuscino unico

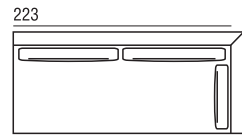

ANGOLO 243 A DX
cuscino unico

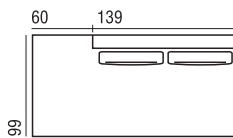

TERMINALE 199 A SX
cuscino unico

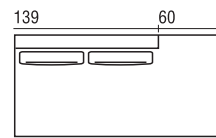

TERMINALE 199 A DX
cuscino unico

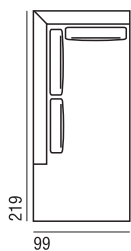

DORMEUSE ANGOLO 219 A SX
cuscino unico

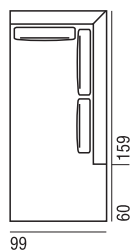

DORMEUSE ANGOLO 219 A DX
cuscino unico

IRVING MODULI SENZA BRACCIOLI VERSIONE B

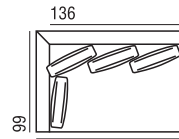

ANGOLO 156 B SX
cuscino unico

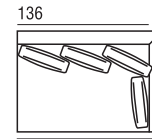

ANGOLO 156 B DX
cuscino unico

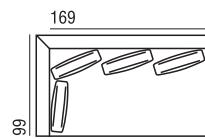

ANGOLO 189 B SX
cuscino unico

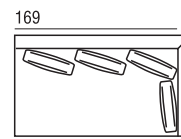

ANGOLO 189 B DX
cuscino unico

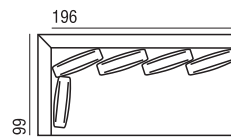

ANGOLO 216 B SX
cuscino unico

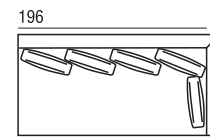

ANGOLO 216 B DX
cuscino unico

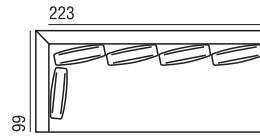

ANGOLO 243 B SX
cuscino unico

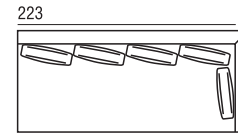

ANGOLO 243 B DX
cuscino unico

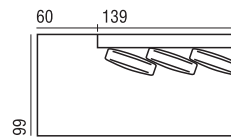

TERMINALE 199 B SX
cuscino unico

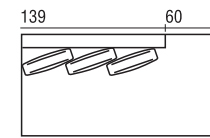

TERMINALE 199 B DX
cuscino unico

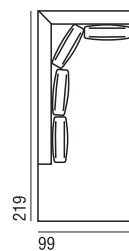

DORMEUSE ANGOLO 219 B SX
cuscino unico

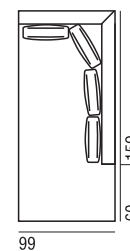

DORMEUSE ANGOLO 219 B DX
cuscino unico



FIANCO POUF

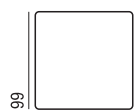

POUF 99x99



POUF 69x99

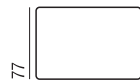

POUF 77x113

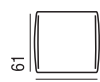

**SCHIENALE
61x65**



**SCHIENALE
53x57**



**SCHIENALE
44x48**



**CUSCINO
42x42**



**CUSCINO
33x54**

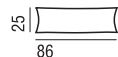

**CUSCINO
POGGIARENI 86**

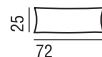

**CUSCINO
POGGIARENI 72**



**CUSCINO
POGGIARENI 56**



**CUSCINO
POGGIARENI 40**

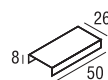

**PIANO APPOGGIO
CUOIO**

COMPLEMENTI

CLUB TAVOLINO Ø 45



FRONTE



PIANTA

CLUB TAVOLINO Ø 59



FRONTE



PIANTA

CLUB TAVOLINO Ø 69



FRONTE



PIANTA

Descrizione composizioni fotografate - Description of the photographed combinations - Beschreibung der gebildeten Zusammenstellungen

Foto pagina - photo at page - Bid auf Seiten: 4/5, 7

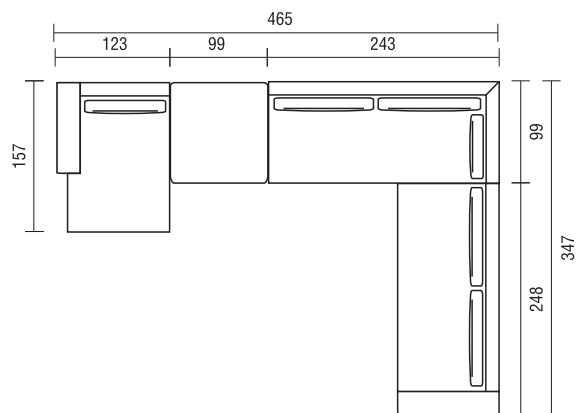

- | | | |
|-------------------------------|-------------------------------|-------------------------------|
| 1 Chaise Longue 123 - 25 A SX | 1 Chaise Longue 123 - 25 A SX | 1 Chaise Longue 123 - 25 A SX |
| 1 Pouf 99x99 | 1 Pouf 99x99 | 1 Hocker 99x99 |
| 1 Angolo 243 A DX | 1 Corner 243 A DX | 1 Eckteil 243 A DX |
| 1 Laterale 248 - 25 A DX | 1 Side piece 248 - 25 A DX | 1 Seitenteil 248 - 25 A DX |

Foto pagina - photo at page - Bid auf Seiten: 8/9

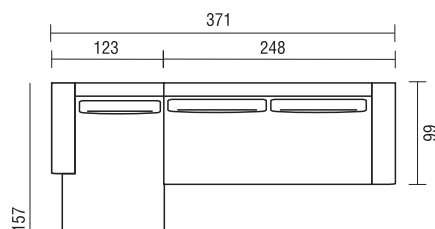

- | | | |
|-------------------------------|-------------------------------|-------------------------------|
| 1 Chaise Longue 123 - 25 A SX | 1 Chaise Longue 123 - 25 A SX | 1 Chaise Longue 123 - 25 A SX |
| 1 Laterale 248 - 25 A DX | 1 Side piece 248 - 25 A DX | 1 Seitenteil 248 - 25 A DX |

Foto pagina - photo at page - Bid auf Seiten: 12/13

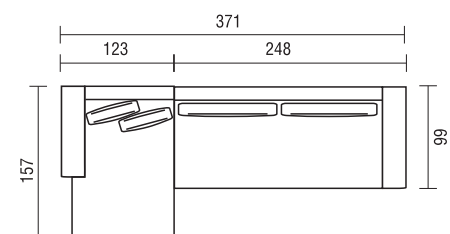

- | | | |
|-------------------------------|-------------------------------|-------------------------------|
| 1 Chaise Longue 123 - 25 B SX | 1 Chaise Longue 123 - 25 B SX | 1 Chaise Longue 123 - 25 B SX |
| 1 Laterale 248 - 25 A DX | 1 Side piece 248 - 25 A DX | 1 Seitenteil 248 - 25 A DX |

Foto pagina - photo at page - Bid auf Seiten: 16/17

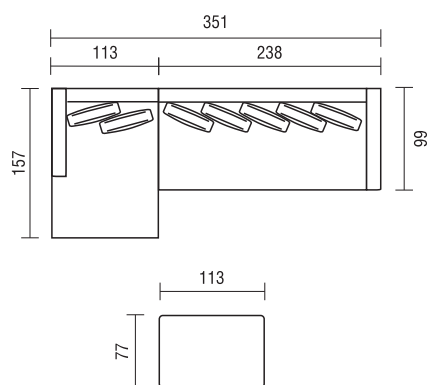

- | | | |
|-------------------------------|-------------------------------|-------------------------------|
| 1 Chaise Longue 113 - 15 B SX | 1 Chaise Longue 113 - 15 B SX | 1 Chaise Longue 113 - 15 B SX |
| 1 Laterale 238 - 15 B DX | 1 Side piece 238 - 15 B DX | 1 Seitenteil 238 - 15 B DX |
| 1 Pouf 77x113 | 1 Pouf 77x113 | 1 Hocker 77x113 |