

## *New collections 2013*

---

*"Architettura e design talvolta ricoprono ruoli complementari ; il nuovo divano "Edmond" di Flexform , disegnato da Carlo Colombo rappresenta attraverso la generosità del segno grafico l'interpretazione neoplasticista di architetture domestiche , dove la struttura in tubolare metallica e' avvolta da un macro intreccio di tessuto che ne scandiscono le forme..... Abbondanti e comode sedute disponibili nelle finiture a catalogo lo rendono poi adatto a qualsiasi ambiente."*

*Carlo Colombo*



**EDMOND**

*"Architecture and design sometimes fulfil complementary roles; through the generosity of its graphic design, the new "Edmond" sofa by Flexform, designed by Carlo Colombo, represents the neoplastic interpretation of domestic architectures, where the tubular metal structure is enveloped by a macro-weaving of fabric giving cadence to its forms..."*

*Generous, comfortable seats available in the finishes in the catalogue make it suitable for any environment."*

*Carlo Colombo*



*"Architektur und Design können sich bestens ergänzen: Das neue Sofa "Edmond" von Flexform, entworfen von Carlo Colombo, repräsentiert mit der Großzügigkeit des grafischen Zeichens die neoplastische Interpretation der häuslichen Architektur, denn das Gestell aus Metallrohren wird von einem Makrogeflecht aus Stoff umhüllt, das die Formen betont...Mit seinen großzügigen, bequemen Sitzflächen, die in den im Katalog genannten Bezügen erhältlich sind, ist es für jedes Ambiente geeignet."*

*Carlo Colombo*

**COLLEZIONE EDMOND / DIVANO**

**CARLO COLOMBO**

DIVANO BASE TELAIO IN METALLO SMALTATO A FORNO CON POLVERI EPOSSIDICHE/STRUTTURA IN METALLO (FINITURE DA VERIFICARE SUL LISTINO) E POLIURETANO RIVESTITO DA TESSUTO PROTETTIVO ACCOPPIATO / CUSCINI SEDUTA IN LEGNO CON IMBOTTITURA IN POLIURETANO RIVESTITO IN TESSUTO PROTETTIVO ACCOPPIATO/ CUSCINI SCHIENALE IN PIUMA CON INSERTO IN MATERIALE INDEFORMABILE/ CUSCINETTI IN PIUMA( SU RICHIESTA CON SUPPLEMENTO DI PREZZO)/ RIVESTIMENTO SFODERABILE IN TESSUTO O PELLE • SOFA, SECTIONAL SOFA, OTTOMAN , CHAISERLONGUE BASE METAL FRAME OVEN ENAMELLED WITH EPOXY POWDER /STRUCTURE METAL AND POLYURETHANE FILLING COVERED IN COATED PROTECTIVE FABRIC / BACK CUSHION FEATHER WITH CRUSHPROOF MATERIAL INSERT / SMALL CUSHIONS FEATHER / COVERING REMOVABLE FABRIC OR LEATHER • SOFAS , MODULARE SOFAS ,OTTOMANE, HÖCKER GESTELL RAHMEN AUS OFENLACKIERTEM METALL MIT EPOXID-PULVERLACK / STRUKTUR AUS METALL UND POLYURETHAN, BEZOGEN MIT SCHUTZ-VERBUNDGEWEBE / SITZFLÄCHE AUS HOLZ MIT POLYURETHANPOLSTERUNG, BEZOGEN MIT SCHUTZ-VERBUNDGEWEBE / RÜCKENKISSEN MIT FEDERFÜLLUNG MIT EINSATZ AUS FORMFESTEM MATERIAL / SOFAKISSEN MIT FEDERFÜLLUNG / BEZUG ABZIEHBARE STOFF- ODER LEDERBEZÜGE

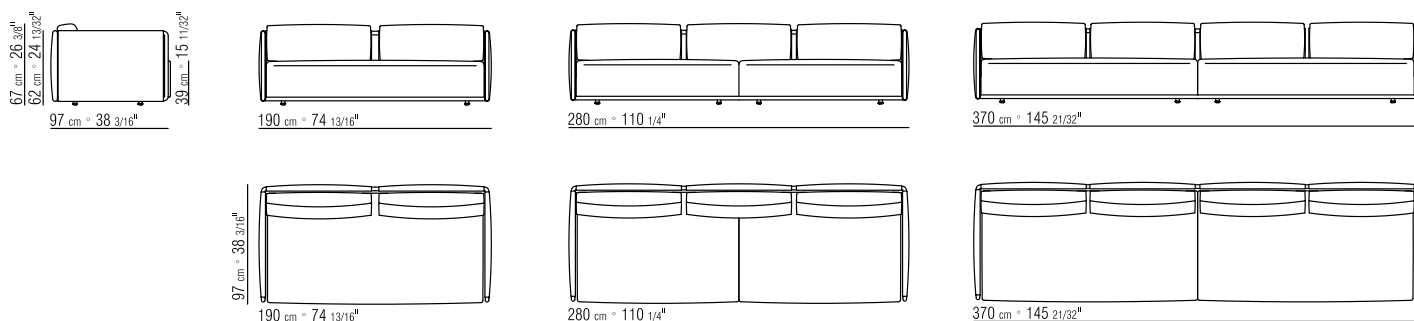

**COLLEZIONE EDMOND / DIVANO CON PENISOLA**

DIVANO COMPONIBILE • SECTIONAL SOFA • SOFA MIT RELAX SITZ

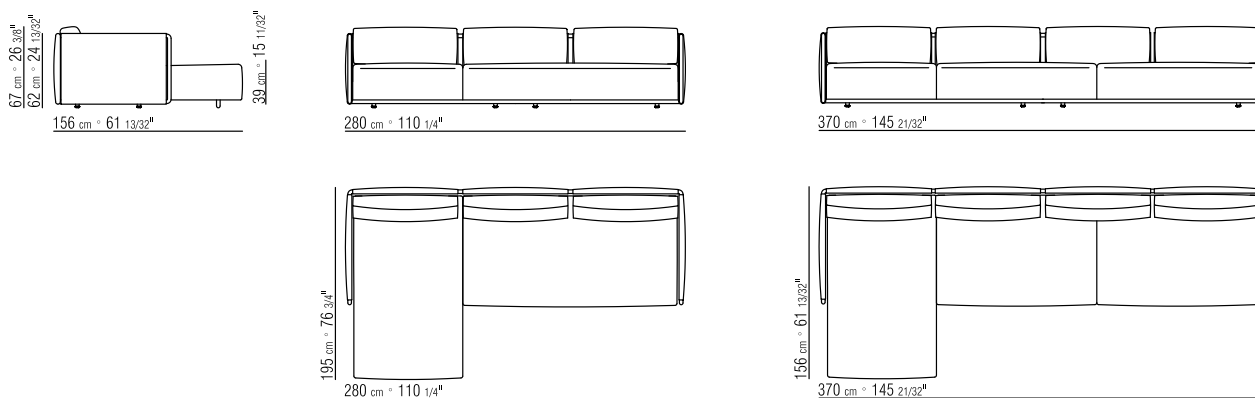

**COLLEZIONE EDMOND / POLTRONA**

POLTRONA • ARMCHAIR • SESSEL

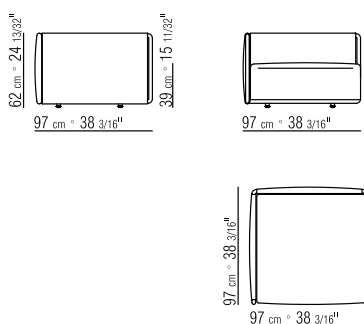

**COLLEZIONE EDMOND / FIANCO**

**CARLO COLOMBO**

FIANCO • END UNIT • ECKE

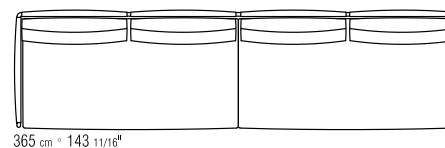
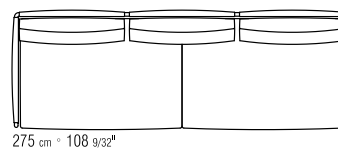
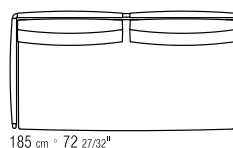
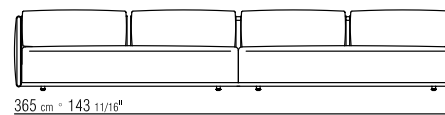
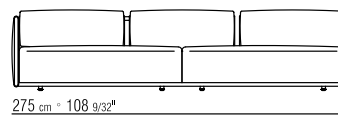
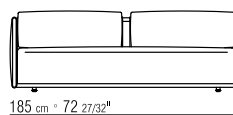
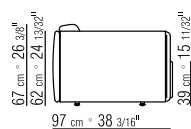

**COLLEZIONE EDMOND / FIANCO TERMINALE**

FIANCO TERMINALE • LONG CORNER • LANGE ECKE

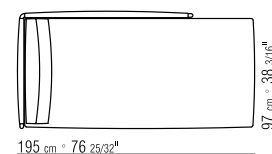
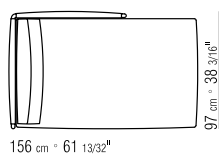
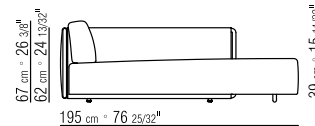
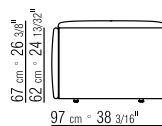
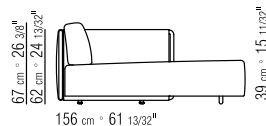
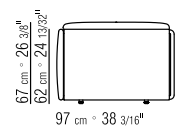

**COLLEZIONE EDMOND / CHAISLONGUE**

CHAISLONGUE • CHAISLONGUE • OTTOMANE

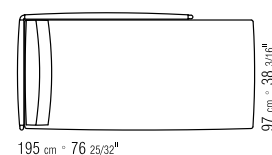
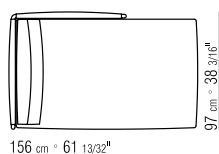
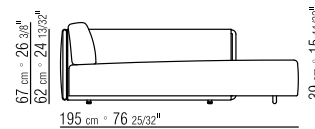
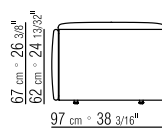
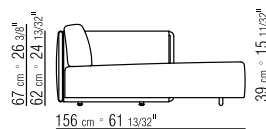
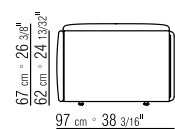

**COLLEZIONE EDMOND / ANGOLO**

**CARLO COLOMBO**

ANGOLO • CORNER • ECKELEMENT

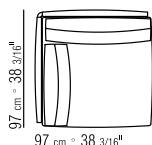
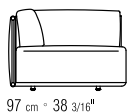
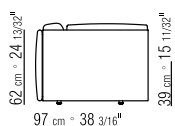

**COLLEZIONE EDMOND / POUF ED ELEMENTO CHIUSURA**

POUF / CUSCINO / ELEMENTO DI CHIUSURA • OTTOMAN / CUSHION / CLOSING UNIT • HOCKER / RUECKENKISSEN / ABSCHLUSSELEMENT

